

AlterMundus

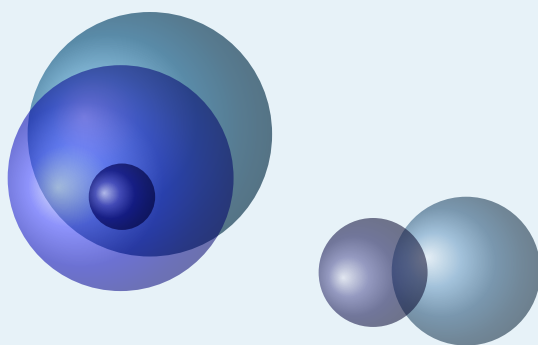

tkz-elements 1.50c

Euclidean Geometry



Alain Matthes

December 8, 2023 Documentation V.1.50c

<http://altermundus.fr>

tkz-elements

Alain Matthes

☞ This document brings together some notes about `tkz-elements`, the first version of a library written in lua, allowing to make all the necessary calculations to define the objects of a Euclidean geometry figure. You need to compile with Lua \LaTeX .

With `tkz-elements`, the definitions and calculations are only done with lua. The main possibility of programmation proposed is oriented "object programming" with object classes like point, line, triangle, circle and ellipse. For the moment, once the calculations are done, it is `tkz-euclide` or TikZ which allows the drawings.

I discovered Lua and object-oriented programming when I created this package, so it's highly probable that I've made a few mistakes. If you'd like to participate in the development of this package or give me advice on how to proceed, please contact me via my email.

This version 1.50c is a beta version.

English is not my native language so there might be some errors.

☞ Acknowledgements : I received much valuable advice, remarks, corrections from Nicolas Kisselhoff, David Carlisle, Roberto Giacomelli and Qrrbrbirlbel.

☞ I would also like to thank Eric Weisstein, creator of [MathWorld](#).

☞ You can find some examples on my site: [altermundus.fr](#). under construction!

Please report typos or any other comments to this documentation to: [Alain Matthes](#).

This file can be redistributed and/or modified under the terms of the \LaTeX Project Public License Distributed from [CTAN](#) archives.

Contents

1	Structure	8
2	Why tkz-elements?	9
2.1	Calculation accuracy	9
2.1.1	Calculation accuracy in TikZ	9
2.1.2	Calculation accuracy in Lua	9
2.1.3	Using objects	9
2.1.4	Example: Apollonius circle	9
3	Presentation	12
3.1	With Lua	12
3.2	The main process	12
3.3	Complete example: Pappus circle	13
3.3.1	The figure	13
3.3.2	The code	13
3.4	Another example with comments: South Pole	14
4	Writing Convention	16
4.1	Miscellaneous	16
4.2	Assigning a Name to a Point	16
4.3	Assigning a Name to Other Objects	17
4.4	Writing conventions for attributes, methods.	17
5	Transfers	18
5.1	From Lua to tkz-euclide or TikZ	18
5.1.1	Points transfer	18
5.1.2	Other transfers	19
6	Class and object	20
6.1	Class	20
6.2	Object	20
6.2.1	Attributes	20
6.2.2	Methods	20
7	Class point	21
7.1	Attributes of a point	21
7.1.1	Example: point attributes	22
7.1.2	Argand diagram	23
7.2	Methods of the class point	24
7.2.1	Example: method north (d)	24
7.2.2	Example: method polar	25
7.2.3	Example: rotation of points	25
7.2.4	Object rotation	25
7.2.5	Object symmetry	26
8	Class line	27
8.1	Attributes of a line	27
8.1.1	Example: attributes of class line	27
8.1.2	Method new and line attributes	28
8.2	Methods of the class line	29
8.2.1	Table of the methods from class line	29
8.2.2	Example: new line from a defined line	30

8.2.3	Example: projection of several points	30
8.2.4	Example: combination of methods	31
8.2.5	Example: translation	31
8.2.6	Example: distance and projection	32
8.2.7	Reflection of object	32
9	Class circle	33
9.1	Attributes of a circle	33
9.1.1	Example: circle attributes	33
9.2	Methods of the class circle	34
9.2.1	Altshiller	35
9.2.2	Lemoine	35
9.2.3	Inversion: point, line and circle	36
9.2.4	Inversion: point	36
9.2.5	Inversion: line	36
9.2.6	Inversion: circle	36
10	Classe triangle	38
10.1	Attributes of a triangle	38
10.1.1	Example: triangle attributes	39
10.2	Methods of the class triangle	40
10.2.1	Euler line	41
10.3	Harmonic division and bisector	42
11	Classe ellipse	44
11.1	Attributes of an ellipse	44
11.1.1	Attributes of an ellipse: example	44
11.2	Methods of the class ellipse	45
11.2.1	Method new	45
11.2.2	Method foci	46
11.2.3	Method point and radii	47
12	Classe Quadrilateral	48
12.1	Quadrilateral Attributes	48
12.1.1	Quadrilateral attributes	48
12.2	Quadrilateral methods	48
12.2.1	Inscribed quadrilateral	49
13	Classe square	50
13.1	Square attributes	50
13.1.1	Example: square attributes	50
13.2	Square methods	51
13.2.1	Square with side method	51
14	Classe rectangle	52
14.1	Rectangle attributes	52
14.1.1	Example	52
14.2	Rectangle methods	53
14.2.1	Angle method	53
14.2.2	Side method	53
14.2.3	Diagonal method	54
14.2.4	Gold method	54

15	Classe <code>parallelogram</code>	55
15.1	Parallelogram attributes	55
15.1.1	Example: attributes	55
15.2	Parallelogram methods	56
15.2.1	<code>parallelogram</code> with fourth method	56
16	Classe <code>Regular Polygon</code>	57
16.1	<code>regular_polygon</code> attributes	57
16.1.1	Pentagon	57
16.2	<code>regular_polygon</code> methods	57
17	Math constants and functions	58
17.0.1	Harmonic division with <code>tkzphi</code>	58
17.0.2	Function <code>islinear</code>	58
17.0.3	Function <code>value</code>	59
17.0.4	Function <code>real</code>	59
17.0.5	Transfer from lua to \TeX	59
17.0.6	Normalized angles : Slope of lines (ab), (ac) and (ad)	59
17.0.7	Get angle	60
17.0.8	Dot or scalar product	61
17.0.9	Alignment or orthogonality	61
17.0.10	Other functions	61
18	Intersections	62
18.1	Line-line	62
18.2	Line-circle	63
18.3	Circle-circle	64
18.4	Line-ellipse	65
19	In-depth study	66
19.1	The tables	66
19.1.1	General tables	66
19.1.2	Table <code>z</code>	67
19.2	Transferts	67
19.3	Complex numbers library and point	68
19.3.1	Example of complex use	68
19.3.2	Point operations(complex)	69
19.4	Barycenter	70
19.4.1	Using the barycentre	70
19.4.2	Incenter of a triangle	70
19.5	Loop and table notation	70
19.6	<code>In_out</code> method	71
19.6.1	<code>In_out</code> for a line	71
19.7	Determinant and dot product	72
19.7.1	Determinant	72
19.7.2	Dot product	72
19.7.3	Dot product: orthogonality test	73
19.7.4	Dot product: projection	73
19.8	Point method	73
20	Examples	75
20.1	D'Alembert 1	75
20.2	D'Alembert 2	75
20.3	Alternate	76

20.4	Apollonius circle	76
20.5	Apollonius and circle circumscribed	77
20.6	Apollonius circles in a triangle	78
20.7	Archimedes	80
20.8	Excircles	81
20.9	Orthogonal circle through	82
20.10	Devine ratio	83
20.11	Director circle	85
20.12	Gold division	85
20.13	Ellipse	86
20.14	Ellipse with radii	87
20.15	Ellipse_with_foci	87
20.16	Euler relation	88
20.17	External angle	90
20.18	Internal angle	90
20.19	Feuerbach theorem	91
20.20	Gold ratio with segment	92
20.21	Gold Arbelos	92
20.22	Harmonic division v1	93
20.23	Harmonic division v2	94
20.24	Menelaus	94
20.25	Radical axis v1	94
20.26	Radical axis v2	95
20.27	Radical axis v3	96
20.28	Radical axis v4	97
20.29	Radical center	99
20.30	Radical circle	100
20.31	Hexagram	100
20.32	Gold Arbelos properties	101
20.33	Apollonius circle v1 with inversion	103
20.34	Apollonius circle v2	104
20.35	Orthogonal circles v1	105
20.36	Orthogonal circles v2	106
20.37	Orthogonal circle to two circles	107
20.38	Midcircles	108
20.39	Pencil v1	110
20.40	Pencil v2	111
20.41	Power v1	112
20.42	Power v2	113
20.43	Reim v1	113
20.44	Reim v2	114
20.45	Reim v3	115
20.46	Tangent and circle	117
20.47	Homothety	117
20.48	Tangent and chord	118
20.49	Three chords	118
20.50	Three tangents	120
20.51	Midarc	120
20.52	Lemoine Line without macro	121
20.53	First Lemoine circle	121
20.54	First and second Lemoine circles	122
20.55	Inversion	123
20.56	Gergonne point	124

20.57	Antiparallel through Lemoine point	125
-------	--	-----

1 Structure

`tkz-elements.sty` loads the `luacode` package, to create the `tkzelements` environment based on the `luacode` environment.

The `tkzelements` environment initializes `scale` to 1 and then deletes all the values in the various tables.

The package defines the two macros `\tkzGetNodes` and `\tkzUseLua`.

The package loads the file `tkz_elements_main.lua`. This file initialise all the tables that will be used by the modules in which the classes are defined.

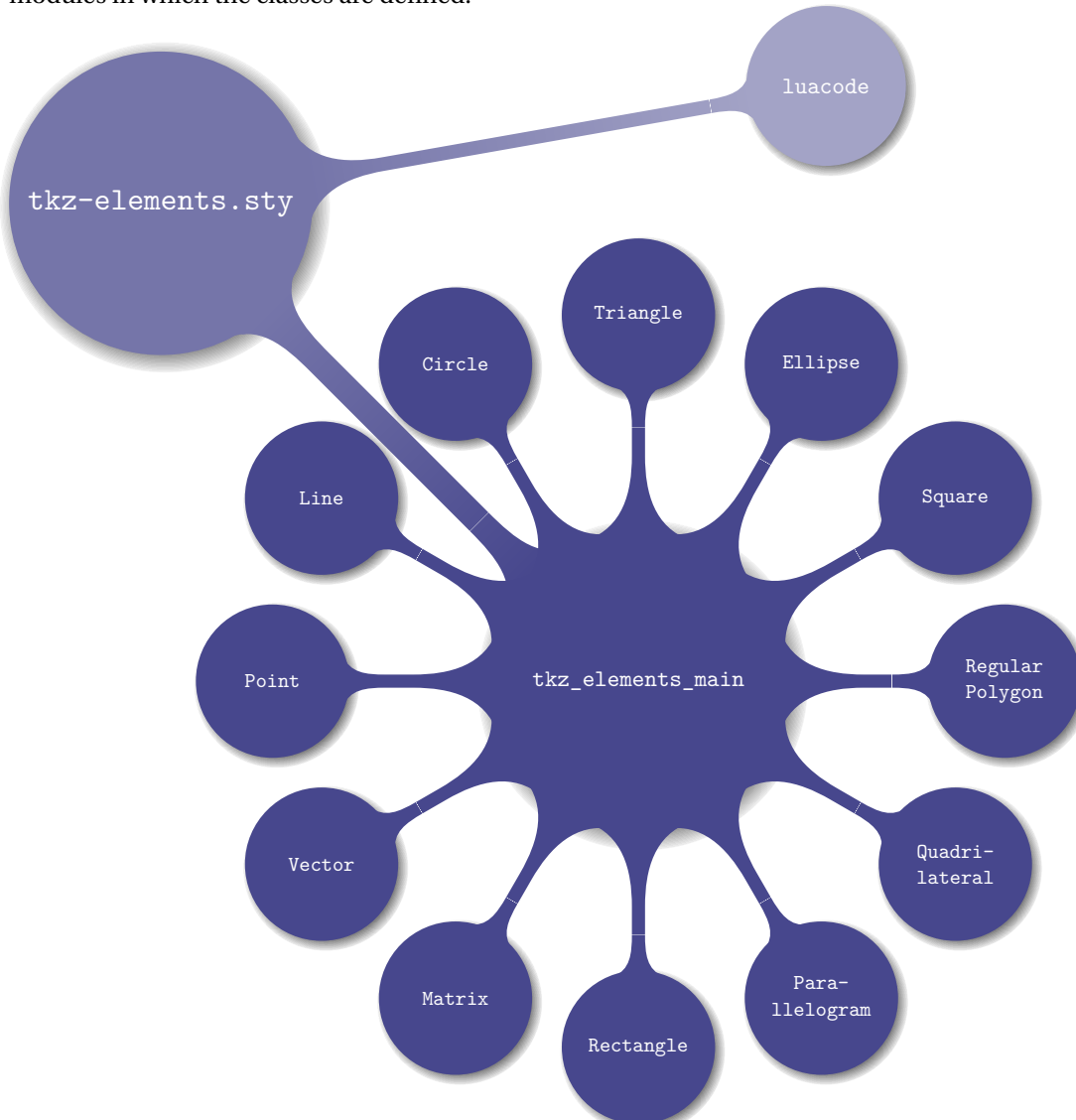

The current classes are (some are still inactive):

- active : point (z) ; line (L) ; circle (C) ; triangle (T) ; ellipse (E) ; quadrilateral (Q) ; square (S) ; rectangle (R) ; parallelogram (P) ; regular_polygon (RP).
- inactive : matrix (M) ; vector (V).

If name is name of a class, you can find its definition in the file `tkz_elements_name.lua`.

2 Why tkz-elements?

2.1 Calculation accuracy

2.1.1 Calculation accuracy in TikZ

With TikZ, `veclen(x,y)` calculates the expression $\sqrt{x^2+y^2}$. This calculation is obtained using a polynomial approximation, based on ideas from Rouben Rostamian.

```
pgfmathparse{veclen(65,72)} \pgfmathresult
```

✎ $\sqrt{65^2+72^2} \approx 96.9884$ 🚫

2.1.2 Calculation accuracy in Lua

A `luaveclen` macro can be defined as follows:

```
\def\luaveclen#1#2{\directlua{tex.print(string.format(
'\percentchar.5f',math.sqrt((#1)*(#1)+(#2)*(#2))))}}
```

and

```
\luaveclen{65}{72}
```

gives

✎ $\sqrt{65^2+72^2} = 97$!!

The error isn't important if it's a hundredth of a pt for the placement of an object on a page, but it's unpleasant for the result of a calculation in a mathematical demonstration. What's more, these inaccuracies can combine to produce erroneous constructions.

To remedy this lack of precision, I first introduced the package `fp`, then the package `xfp`. Lately, with the arrival of `luaLaTeX`, I have been able to add a Lua option whose goal was to perform some calculations with Lua.

This was the primary reason for creating the package, the second being the introduction of object-oriented programming and easier programming with Lua. Object-oriented programming (oop) convinced me to further develop all the possibilities this method offered.

At that moment, I had received some examples of programming with Lua from [Nicolas Kisselhoff](#), but I didn't understand its code, so I had to patiently study Lua. Finally, I was able to build `tkz-elements`, I took many of his ideas I've adapted.

2.1.3 Using objects

Then, I read an article¹ by [Roberto Giacomelli](#) on object programming based on the Lua and TikZ tools. This was my second source of inspiration. Not only could the programming be done step-by-step, but the introduction of objects allowed the link between the code and the geometry. The code becomes more readable, more explicit and better structured.

2.1.4 Example: Apollonius circle

Problem The goal is to determine an inner tangent circle to the three exinscribed circles of a triangle.

See [MathWorld](#) for more details.

¹ [Grafica ad oggetti con LuaTeX](#)

This example was my reference for testing the tkz-euclide package. With my first methods and the tools at my disposition, the results lacked precision. Now, with tkz-elements, I can use tools that are more powerful, more precise and easier to create.

The essential principles of figure construction with `tkz-euclide` are kept: definitions, calculations, tracings, labels as well as the step-by-step programming, corresponding to a construction with a ruler and a compass. This is the version that uses the simplest construction method, made possible by Lua.

```
\begin{tkzelements}
  scale          = .4
  z.A            = point: new (0,0)
  z.B            = point: new (6,0)
  z.C            = point: new (0.8,4)
  T.ABC          = triangle : new ( z.A,z.B,z.C )
  z.N            = T.ABC.eulercenter
  z.S            = T.ABC.spiekercenter
  T.feuerbach    = T.ABC : feuerbach ()
  z.Ea,z.Eb,z.Ec = get_points ( T.feuerbach )
  T.excentral    = T.ABC : excentral ()
  z.Ja,z.Jb,z.Jc = get_points ( T.excentral )
  C.JaEa         = circle: new (z.Ja,z.Ea)
  C.ortho        = circle: radius (z.S,math.sqrt(C.JaEa: power(z.S)))
  z.a            = C.ortho.through
  C.euler        = T.ABC: euler_circle ()
  C.apo          = C.ortho : inversion (C.euler)
  z.O            = C.apo.center
  z.xa,z.xb,z.xc = C.ortho : inversion (z.Ea,z.Eb,z.Ec)
\end{tkzelements}
```

The creation of an object encapsulates its attributes (its characteristics) and methods (i.e. the actions that are specific to it). It is then assigned a reference (a name), which is linked to the object using a table. The table is an associative array that links the reference called key to a value, in this case the object. These notions will be developed later.

T is a table that associates the object `triangle` with the key `ABC`. `T.ABC` is also a table, and its elements are accessed using keys that are attributes of the triangle. These attributes have been defined in the package.

```
z.N = T.ABC.eulercenter
```

N is the name of the point, `eulercenter` is an attribute of the triangle.²

```
T.excentral = T.ABC : excentral ()
```

Here, `excentral` is a method linked to the `T.ABC` object. It defines the triangle formed by the centers of the exinscribed circles.

Two lines are important. The first below shows that the excellent precision provided by Lua makes it possible to define a radius with a complex calculation. The radius of the radical circle is given by $\sqrt{\Pi(S, \mathcal{C}(J_a, E_a))}$ (square root of the power of point *S* with respect to the exinscribed circle with center *Ja* passing through *Ea*).

```
C.ortho = circle: radius (z.S,math.sqrt(C.JaEa: power(z.S)))
```

² The center of the Euler circle, or center of the nine-point circle, is a characteristic of every triangle.

Finally, the inversion of the Euler circle with respect to the radical circle is the Apollonius circle³. The transformation has an object as parameter, which is recognized by its type (all objects are typed in the package), and the method determines which algorithm to use according to this type.

```
C.apo = C.ortho : inversion (C.euler)
```

Now that all the points have been defined, it's time to start drawing the paths. To do this, you need to create the nodes. This is the role of the macro . See 5.1.1

The following section concerns only drawings, and is handled by tkz-euclide.

```
\begin{tikzpicture}
  \tkzGetNodes
  \tkzFillCircles[green!30](O,xa)
  \tkzFillCircles[teal!30](Ja,Ea Jb,Eb Jc,Ec)
  \tkzFillCircles[lightgray](S,a)
  \tkzFillCircles[green!30](N,Ea)
  \tkzDrawPoints(xa,xb,xc)
  \tkzClipCircle(O,xa)
  \tkzDrawLines[add=3 and 3](A,B A,C B,C)
  \tkzDrawCircles(Ja,Ea Jb,Eb Jc,Ec S,a O,xa N,Ea)
  \tkzDrawPoints(O,A,B,C,S,Ea,Eb,Ec,N)
  \tkzDrawSegments[dashed](S,xa S,xb S,xc)
  \tkzLabelPoints(O,N,A,B)
  \tkzLabelPoints[right](S,C)
\end{tikzpicture}
```

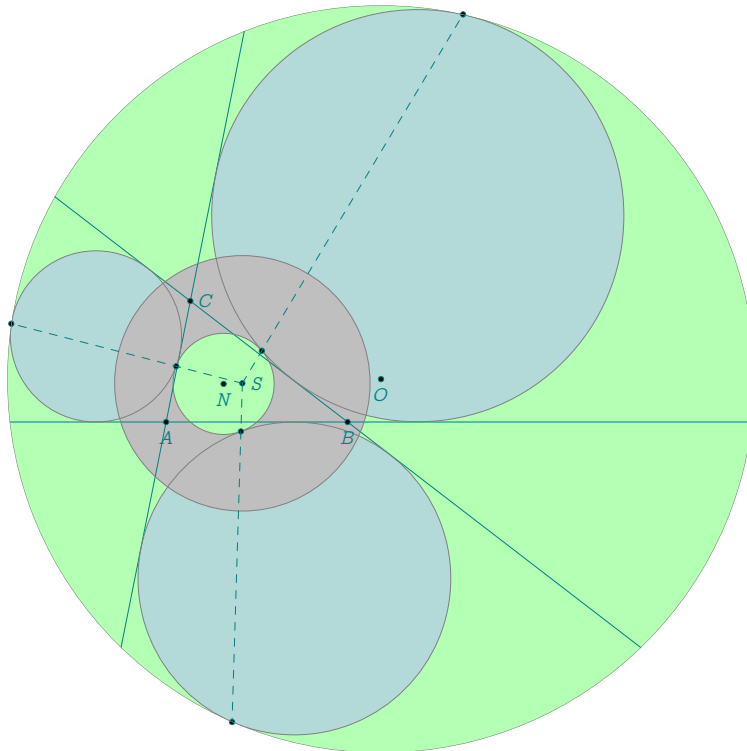

³ The nine-point circle, or Euler circle, is externally tangent to the three circles. The points of tangency form Feuerbach's triangle.

3 Presentation

3.1 With Lua

The purpose of tkz-elements is simply to calculate dimensions and define points. This is done in Lua. You can think of tkz-elements as a kernel that will be used either by tkz-euclide or by TikZ, see MetaPost. Definitions and calculations are done inside the environment `tkzelements`, this environment is based on `luacode`.

The key points are:

- the source file must be `utf8` encoded;
- compilation is done with `LuaLaTeX`;
- you need to load TikZ ou tkz-euclide and tkz-elements;
- definitions and calculations are performed in an orthonormal sytem of reference, using Lua, and are carried out in an environment of `tkzelements`.

To the right, see the minimum template.

The code is divided into two parts, which are two environments `tkzelements` and `tikzpicture`. In the first environment, you place your Lua code, and in the second, tkz-euclide commands.

```
% !TEX TS-program = lualatex
% Created by Alain Matthes
\documentclass{standalone}
\usepackage{tkz-euclide}
% or simply TikZ
\usepackage{tkz-elements}
begin{document}

\begin{tkzelements}
  scale = 1
  % definition of some points
  z.A = point : new ( , )
  z.B = point : new ( , )

  ...code...
\end{tkzelements}

\begin{tikzpicture}
% point transfer to Nodes
\tkzGetNodes

\end{tikzpicture}
\end{document}
```

3.2 The main process

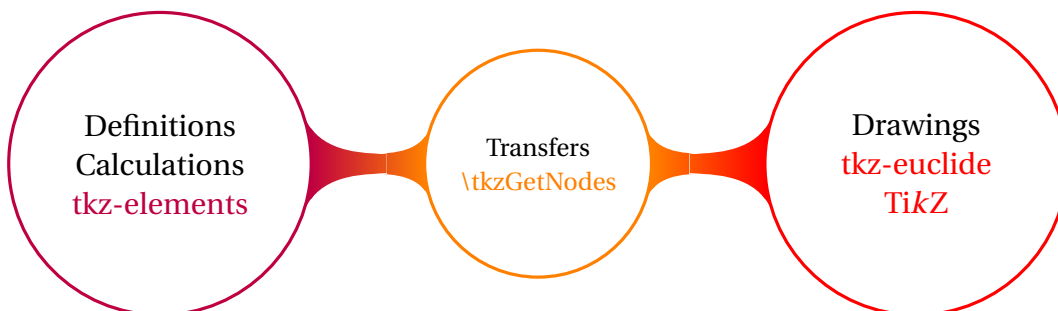

When all the points necessary for the drawing are obtained, they must be transformed into `nodes` so that TikZ or tkz-euclide can draw the figure. This is done through the macro `\tkzGetNodes`. This macro browse all the elements of the table `z` using the key (in fact the name of the point) and retrieves the values associated with it, i.e. the coordinates of the point (node).

3.3 Complete example: Pappus circle

3.3.1 The figure

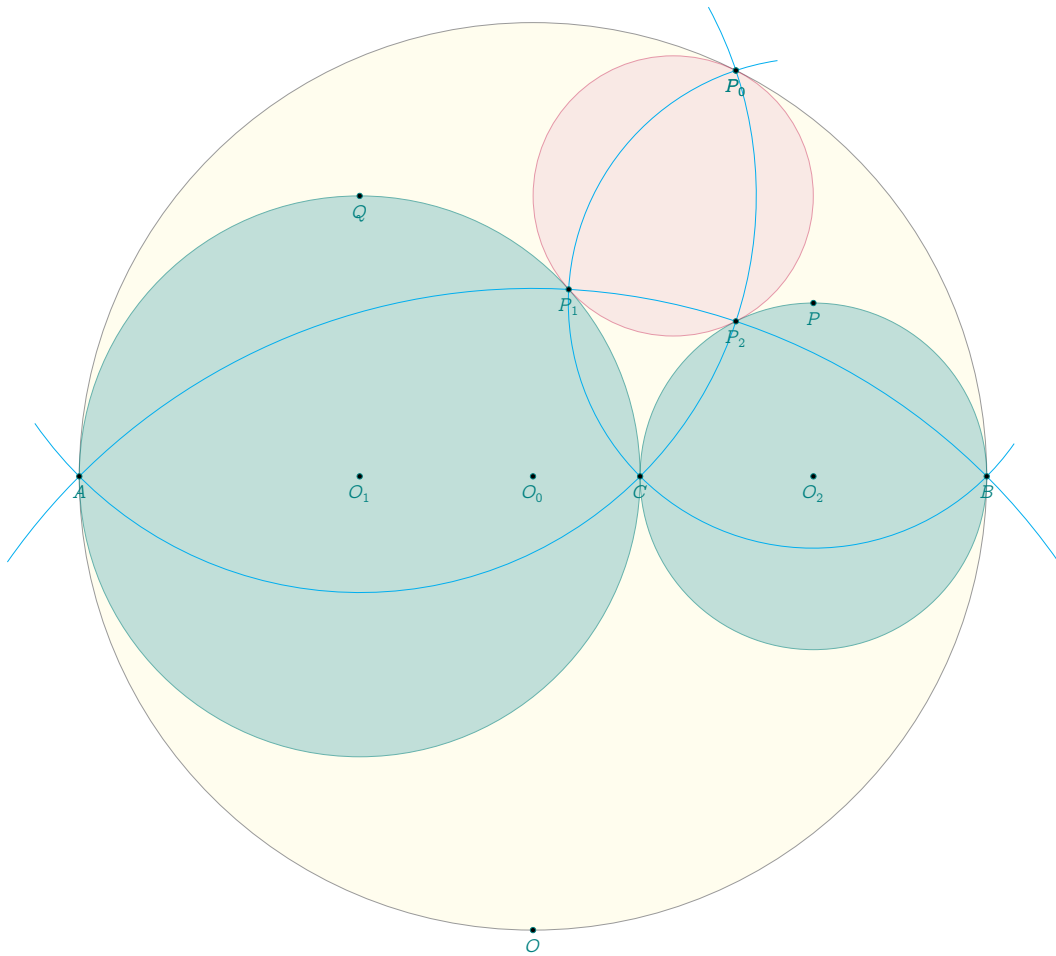

3.3.2 The code

```

1 % !TEX TS-program = lualatex
2 \documentclass{article}
3 \usepackage{tkz-euclide}
4 \usepackage{tkz-elements}
5 \begin{document}
6
7 \begin{tkzelements}
8 z.A = point: new (0 , 0)
9 z.B = point: new (10 , 0)      creation of two fixed points $A$ and $B$
10 L.AB = line: new ( z.A, z.B)
11 z.C = L.AB: gold_ratio ()     use of a method linked to "line"
12 z.O_0 = line: new ( z.A, z.B).mid midpoint of segment with an attribute of "line"
13 z.O_1 = line: new ( z.A, z.C).mid objects are not stored and cannot be reused.
14 z.O_2 = line: new ( z.C, z.B).mid
15 C.AB = circle: new ( z.O_0, z.B) new object "circle" stored and reused
16 C.AC = circle: new ( z.O_1, z.C)
17 C.CB = circle: new ( z.O_2, z.B)
18 z.P = C.CB.north             "north" attributes of a circle

```

```

19 z.Q      = C.AC.north
20 z.O      = C.AB.south
21 z.c      = z.C : north (2)           "north" method of a point (needs a parameter)
22 C.PC     = circle: new ( z.P, z.C)
23 C.QA     = circle: new ( z.Q, z.A)
24 z.P_0    = intersection (C.PC,C.AB)  search for intersections of two circles.
25 z.P_1    = intersection (C.PC,C.AC)  idem
26 _,z.P_2  = intersection (C.QA,C.CB)  idem
27 z.O_3    = triangle: new ( z.P_0, z.P_1, z.P_2).circumcenter attribute of "triangle"
28 \end{tkzelements}
29
30 \begin{tikzpicture}
31   \tkzGetNodes
32   \tkzDrawCircle[black,fill=yellow!20,opacity=.4] (O_0,B)
33   \tkzDrawCircles[teal,fill=teal!40,opacity=.6] (O_1,C O_2,B)
34   \tkzDrawCircle[purple,fill=purple!20,opacity=.4] (O_3,P_0)
35   \tkzDrawArc[cyan,delta=10] (Q,A) (P_0)
36   \tkzDrawArc[cyan,delta=10] (P,P_0) (B)
37   \tkzDrawArc[cyan,delta=10] (O,B) (A)
38   \tkzDrawPoints(A,B,C,O_0,O_1,O_2,P,Q,P_0,P_1,P_2,O)
39   \tkzLabelPoints(A,B,C,O_0,O_1,O_2,P,Q,P_0,P_1,P_2,O)
40 \end{tikzpicture}
41 \end{document}

```

3.4 Another example with comments: South Pole

Here's another example with comments

```

% !TEX TS-program = lualatex
\documentclass{standalone}
\usepackage{tkz-euclide,tkz-elements}
\begin{document}
\begin{tkzelements}
  z.A      = point: new (2 , 4)
  z.B      = point: new (0 , 0)
  z.C      = point: new (8 , 0)
  T.ABC    = triangle: new (z.A,z.B,z.C)
  C.ins    = T.ABC: in_circle ()
  z.I      = C.ins.center
  z.T      = C.ins.through
  -- z.I,z.T = get_points (C.ins)
  C.cir    = T.ABC : circum_circle ()
  z.W      = C.cir.center
  z.O      = C.cir.south
  L.AO     = line: new (z.A,z.O)
  L.BC     = T.ABC.bc
  z.I_A    = intersection (L.AO,L.BC)
\end{tkzelements}

```

we create environment tkzelements
 three fixed points are used
 we create a new triangle object
 we get the incircle of this triangle
 center is an attribute of the circle
 through is also an attribute
 get_points is a shortcut
 we get the circumscribed circle
 we get the center of this circle
 now we get the south pole of this circle
 we create an object "line"
 we get the line (BC)
 we search the intersection of the last lines

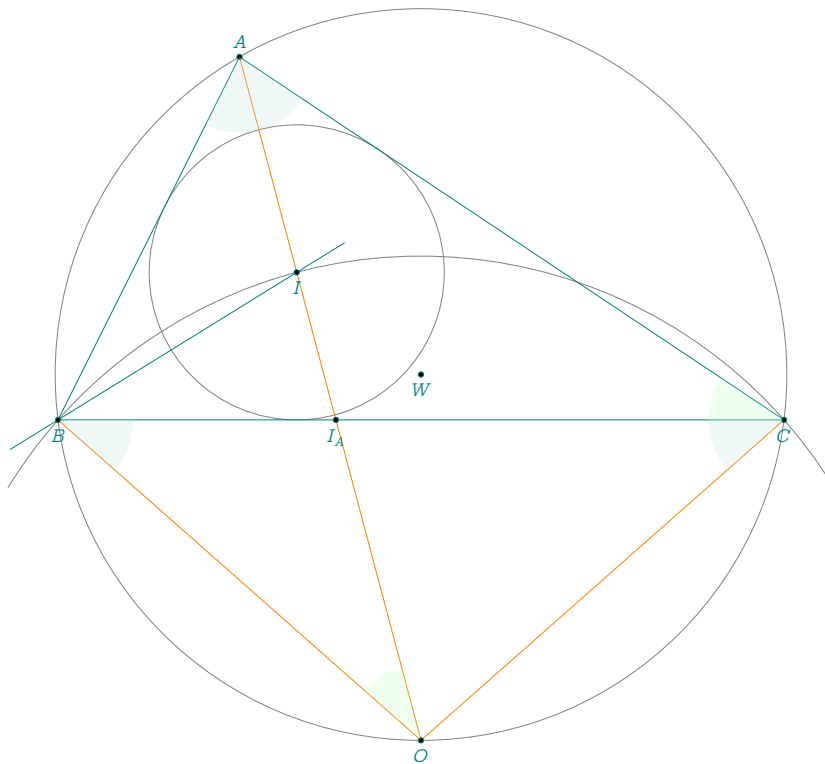

Here's the tikzpicture environment to obtain the drawing:

```

\begin{tikzpicture}
\tkzGetNodes
\tkzDrawCircles(W,A I,T)
\tkzDrawArc(O,C)(B)
\tkzDrawPolygon(A,B,C)
\tkzDrawSegments[new](A,O B,O C,O)
\tkzDrawLine(B,I)
\tkzDrawPoints(A,B,C,I,I_A,W,O)
\tkzFillAngles[green!20,opacity=.3](A,O,B A,C,B)
\tkzFillAngles[teal!20,opacity=.3](O,B,C B,C,O B,A,O O,A,C)
\tkzLabelPoints(I,I_A,W,B,C,O)
\tkzLabelPoints[above](A)
\end{tikzpicture}

```

4 Writing Convention

4.1 Miscellaneous

- Numerical variable: the writing conventions for real numbers are the same as for Lua.
- Complex numbers: as for real numbers but to define them you must write `za = point (1,2)`. Mathematically, this corresponds to $1+2i$, which you can find with `tex.print(tostring(za))`. (see 19.3)
- Boolean: you can write `bool = true` or `bool = false` then with Lua you can use the code :

```
if bool == ... then ... else ... end
```

and outside the environment `tkzelements` you can use the macro

```
\ifthenelse{\equal{\tkzUseLua{bool}}{true}}{ ... }{ ... }
```

after loading the `ifthen` package.

- String: if `st = "Euler's formula"` then

```
\tkzUseLua{st} gives Euler's formula
```

4.2 Assigning a Name to a Point

Currently the only obligation is to store the points in the table `z`⁴ if you want to use them in `TikZ` or `tkz-euclide`. If it is a point which will not be used, then you can designate it as you wish by respecting the conventions of Lua. The points which occur in the environment `tkzelements` must respect a convention which is `z.name` such that name will be the name of the corresponding node.

What are the conventions for designating name? You have to respect the Lua conventions in particular cases.

1. The use of prime is problematic. If the point name contains more than one symbol and ends with `p` then when passing into `TikZ` or `tkz-euclide`, the letters `p` will be replaced by `'` using the macro `\tkzGetNodes`;
2. One possibility, however, in order to have a more explicit code is to suppose that you want to designate a point by "euler". It would be possible for example to write `euler = ...`, and at the end of the code for the transfer, `z.E = euler`. It is also possible to use a temporary name `euler` and to replace it in `TikZ`. Either at the time of placing the labels, or for example by using `pgfnodealias{E}{euler}`. This possibility also applies in other cases: prime, double prime, etc.

Here are some different ways of naming a point:

- `z.A = point : new (1,2)`
- `z.Bp = point : new (3,4) -> this gives B' in the tikzpicture`
- `z.H_a = T.ABC : altitude () -> this gives H_a in the tikzpicture code and H_a in the display.`

⁴ To place the point `M` in the table, simply write `z.M = ...` or `z["M"] = ...`

4.3 Assigning a Name to Other Objects

You have the choice to give a name to objects other than points. That said, it is preferable to respect certain rules in order to make the code easier to read. I have chosen for my examples the following conventions: first of all I store the objects in tables: `L.name` for lines and segments, `C.name` for circles, `T.name` for triangles, `E.name` for ellipses.

For lines, I use the names of the two points. So if a line passes through points A and B , I name the line `L.AB`.

For circles, I name `C.AB` the circle of center A passing through B , but something like `C.euler` or `C.external` is fine.

For triangles, I name `T.ABC` the triangle whose vertices are A , B and C but `T.feuerbach`.

For ellipses, I name `E.ABC` the ellipse with center A through vertex B and covertex C .

4.4 Writing conventions for attributes, methods.

You must use the conventions of Lua, so

- To obtain an attribute, for all objects, the convention is identical: `object.attribute`. For example, for the point A we access its abscissa with `z.A.re` and its ordinate with `z.A.im`; as for its type we obtain it with `z.A.type`. To get the south pole of the circle `C.OA` you need to write: `C.OA.south`.
- To use a method such as obtaining the incircle of a triangle ABC , just write
`C.incircle = T.ABC : in_circle ()`.
- Some methods need a parameter. For example, to know the distance between a point C to the line (A,B) we will write
`d = L.AB : distance (z.C)`.
- Use the underscore to store a result you don't want to use. If you only need the second point of an intersection between a line and a circle, you would write
`_,z.J = intersection (L.AB , C.OC)`.

5 Transfers

5.1 From Lua to tkz-euclide or TikZ

In this section, we'll look at how to transfer points, Booleans and numerical values.

5.1.1 Points transfer

We use an environment `tkzelements` outside an environment `tikzpicture` which allows us to carry out all the necessary calculations, then we launch the macro which transforms the affixes of the table `z` into `Nodes`. It only remains to draw.

Currently the drawing program is either `TikZ` or `tkz-euclide`. You have the possibility to use another package to trace but for that you have to create a macro similar to `\tkzGetNodes`. Of course, this package must be able to store the points as does `TikZ` or `tkz-euclide`.

```
\def\tkzGetNodes{\directlua{%
  for K,V in pairs(z) do
    local n,sd,ft
    n = string.len(K)
    if n >1 then
      _,_,ft, sd = string.find( K , "(.+)(")
      if sd == "p" then K=ft.."'" end
    end
    tex.print("\coordinate ("..K..) at ("..V.re..","..V.im..) ;\\")
  end}
}
```

See the section In-depth Study 19 for an explanation of the previous code.

The environment `tkzelements` allows to use the underscore `_` and the macro `\tkzGetNodes` allows to obtain names of nodes containing prime. (see the next example)

```
\begin{tkzelements}
  scale = 1.2
  z.o = point: new (0,0)
  z.a_1 = point: new (2,1)
  z.a_2 = point: new (1,2)
  z.ap = z.a_1 + z.a_2
\end{tkzelements}
\begin{tikzpicture}
  \tkzGetNodes
  \tkzDrawSegments(o,a_1 o,a_2 o,a')
  \tkzDrawSegments[red](a_1,a' a_2,a')
  \tkzDrawPoints(a_1,a_2,a',o)
  \tkzLabelPoints(o,a_1,a_2,a')
\end{tikzpicture}
```

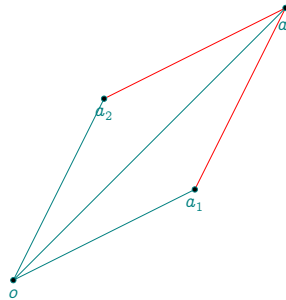

5.1.2 Other transfers

Sometimes it's useful to transfer angle, length measurements or boolean. For this purpose, I have created the macro (see 17.0.5) `tkzUseLua(value)`

```
\begin{tkzelements}
  z.b = point: new (1,1)
  z.a = point: new (4,2)
  z.c = point: new (2,2)
  z.d = point: new (5,2)
  L.ab = line : new (z.a,z.b)
  L.cd = line : new (z.c,z.d)
  det = (z.b-z.a)^(z.d-z.c)
  if det == 0 then bool = true
    else bool = false
  end
  x = intersection (L.ab,L.cd)
\end{tkzelements}
```

The intersection of the two lines lies at
a point whose affix is: `\tkzUseLua{x}`

```
\begin{tikzpicture}
  \tkzGetNodes
  \tkzDrawPoints(a,...,d)
  \ifthenelse{\equal{\tkzUseLua{bool}}{true}}{
  \tkzDrawSegments[red](a,b c,d)}{
  \tkzDrawSegments[blue](a,b c,d)}
  \tkzLabelPoints(a,...,d)
\end{tikzpicture}
```

The intersection of the two lines lies at a point whose affix is: `3.0+1.6666666666667i`

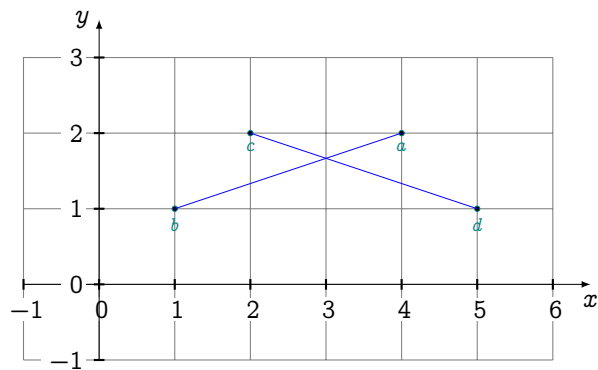

6 Class and object

6.1 Class

Object-oriented programming (OOP) is defined as a programming model built on the concept of objects. An object can be defined as a data table that has unique attributes and methods (operations) that define its behavior.

A class is essentially a user-defined data type. It describes the contents of the objects that belong to it. A class is a blueprint of an object, providing initial values for attributes and implementations of methods⁵ common to all objects of a certain kind.

6.2 Object

An Object is an instance of a class. Each object contains attributes and methods. Attributes are information or object characteristics stored in the data table (called field). The methods define behavior.

All objects in the package are typed. The object types currently defined and used are: `point`, `line`, `circle`, `triangle`, `ellipse`, `quadrilateral`, `square`, `rectangle`, `parallelogram` and `regular_polygon`.

They can be created directly using the method `new` by giving points, with the exception of the `classpoint` class which requires a pair of reals, and `classregular_polygon` which needs two points and an integer.

Objects can also be obtained by applying methods to other objects. For example, `T.ABC : circum_circle ()` creates an object `circle`. Some object attributes are also objects, such as `T.ABC.bc` which creates the object `line`, a straight line passing through the last two points defining the triangle.

6.2.1 Attributes

Attributes are accessed using the classic method, so `T.pc` gives the third point of the triangle and `C.OH.center` gives the center of the circle, but I've added a `get_points` function that returns the points of an object. This applies to straight lines (`pa` and `pc`), triangles (`pa`, `pb` and `pc`) and circles (`center` and `through`).

Example: `z.O,z.T = get_points (C)` recovers the center and a point of the circle.

6.2.2 Methods

A method is an operation (function or procedure) associated (linked) with an object.

Example: The point object is used to vertically determine a new point object located at a certain distance from it (here 2). Then it is possible to rotate objects around it.

```
\begin{tkzelements}
  z.A = point (1,0)
  z.B = z.A : north (2)
  z.C = z.A : rotation (math.pi/3,z.B)
  tex.print(tostring(z.C))
\end{tkzelements}
```

The coordinates of C are: -0.73205080756888 and 1.0

⁵ action which an object is able to perform.

7 Class point

The class on which the whole edifice rests, it's the class point. This class is hybrid in the sense that it is as much about points of a plane as complex numbers. The principle is the following: the plane is provided with an orthonormal basis which allows us to determine the placement of a point using its abscissa and ordinate coordinates; in the same way any complex number can simply be considered as a pair of real numbers (its real part and its imaginary part). We can then designate the plane as the complex plane, and the complex number $x + iy$ is represented by the point of the plane with coordinates (x, y) . Thus the point A will have coordinates stored in the object $z.A$. Coordinates are attributes of the "point" object, like type, argument and modulus.

The creation of a point is done using the following method, but there are other possibilities. If a scaling factor has been given, the method takes it into account.

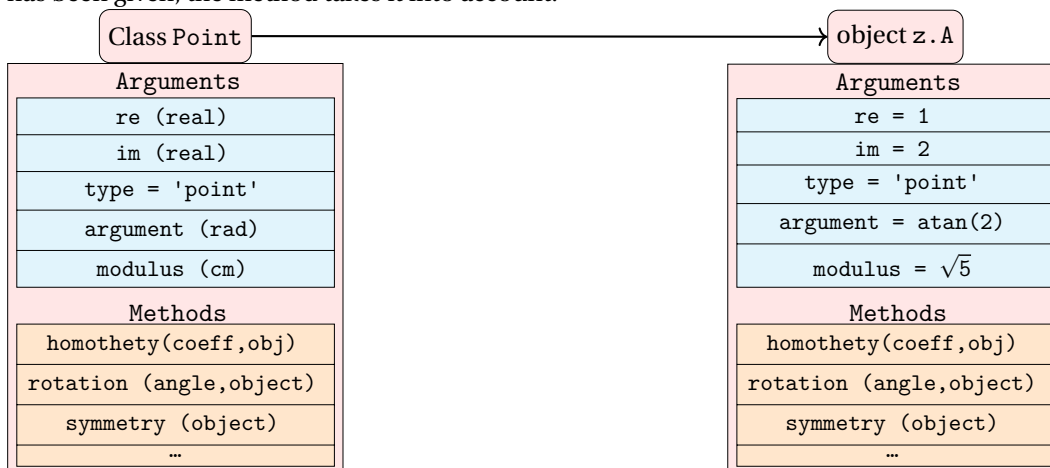

7.1 Attributes of a point

```
Creation z.A = point: new (1,2)
```

The point A has coordinates $x = 1$ and $y = 2$. If you use the notation $z.A$ then A will be the reference of a node in TikZ or in tkz-euclide.

This is the creation of a fixed point with coordinates 1 and 2 and which is named A . The notation $z.A$ indicates that the coordinates will be stored in a table noted z (reference to the notation of the affixes of the complex numbers) that A is the name of the point and the key allowing access to the values.

Table 1: Point attributes.

Attributes	Application	
re	$z.A.re$	$\rightarrow z.A = \text{point:new (1,2)} \quad x = z.A.re=1$
im	$z.A.im$	$\rightarrow z.A = \text{point:new (1,2)} \quad y = z.A.im=2$
type	$z.A.type$	$\rightarrow z.A.type = 'point'$
argument	$z.A.argument$	$\rightarrow z.A.argument \approx 0.78539816339745$
module	$z.A.module$	$\rightarrow z.A.module \approx 2.2360659740269 \approx \sqrt{5}$

7.1.1 Example:point attributes

```

\begin{tkzelements}
  z.M = point: new (1,2)
\end{tkzelements}

\begin{tikzpicture}[scale = 1]
\pgfkeys{/pgf/number format/.cd,std,precision=2}
\let\mpmn\pgfmathprintnumber
\tkzDefPoints{2/4/M,2/0/A,0/0/O,0/4/B}
\tkzLabelPoints(O)
\tkzMarkAngle[fill=gray!30,size=1](A,O,M)
\tkzLabelAngle[pos=1,right](A,O,M){%
 $\theta \approx \mpmn{\tkzUseLua{z.M.argument}}$  rad}
\tkzDrawSegments(O,M)
\tkzLabelSegment[above,sloped](O,M){%
 $|z_M| = \sqrt{5} \approx \mpmn{\tkzUseLua{z.M.modulus}}$  cm}
\tkzLabelPoint[right](M){ $M : z_M = 1 + 2i$ }
\tkzDrawPoints(M,A,O,B)
\tkzPointShowCoord(M)
\tkzLabelPoint[below,teal](A){ $\tkzUseLua{z.M.re}$ }
\tkzLabelPoint[left,teal](B){ $\tkzUseLua{z.M.im}$ }
\tkzDrawSegments[->,add = 0 and 0.25](O,B O,A)
\end{tikzpicture}

```

Attributes of $z.M$

- $z.M.re = 1$
- $z.M.im = 2$
- $z.M.type = 'point'$
- $z.M.argument = \theta \approx 1.11 \text{ rad}$
- $z.M.modulus = |z_M| = \sqrt{5} \approx 2.24 \text{ cm}$

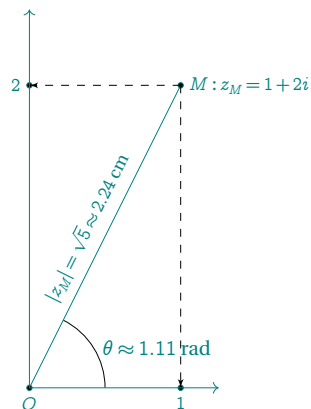

7.1.2 Argand diagram

```

\begin{tkzelements}
  z.A = point : new ( 2 , 3 )
  z.O = point : new ( 0 , 0 )
  z.I = point : new ( 1 , 0 )
\end{tkzelements}
\hspace{\fill}\begin{tikzpicture}
  \tkzGetNodes
  \tkzInit[xmin=-4,ymin=-4,xmax=4,ymax=4]
  \tkzDrawCircle[dashed,red](O,A)
  \tkzPointShowCoord(A)
  \tkzDrawPoint(A)
  \tkzLabelPoint[above right](A){\normalsize  $a+ib$ }
  \tkzDrawX\tkzDrawY
  \tkzDrawSegment(O,A)
  \tkzLabelSegment[above,anchor=south,sloped](O,A){ OA = modulus of  $z_A$ }
  \tkzLabelAngle[anchor=west,pos=.5](I,O,A){ $\theta$  = argument of  $z_A$ }
\end{tikzpicture}

```

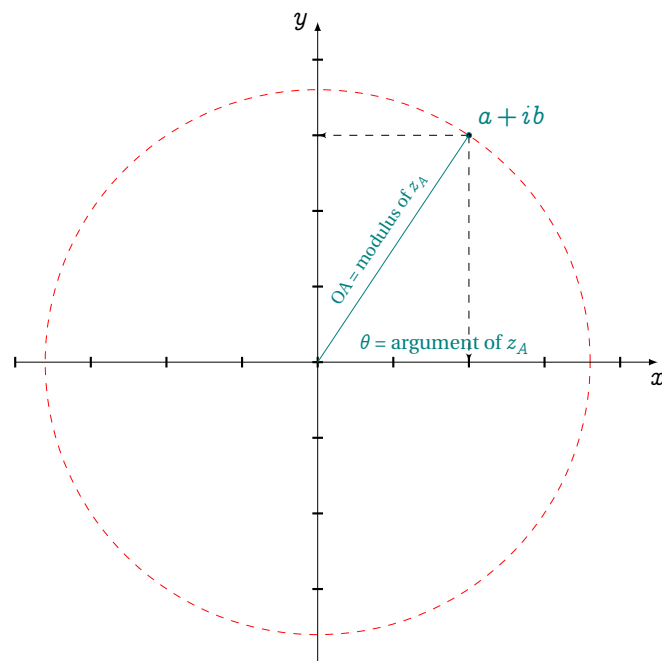

7.2 Methods of the class point

The methods described in the following table are standard. You'll find them in most of the examples at the end of this documentation. The result of the different methods presented in the following table is a `point`.

Table 2: Methods of the class point.

Methods	Application	
<code>new (a,b)</code>	<code>z.a = point : new(1,2)</code>	-> affix $z.a=1+2i$
<code>polar (radius, phi)</code>	<code>z.a = point : polar(1,math.pi/3)</code>	-> affix $\cos(\pi/3) + \sin(\pi/3)i$
<code>polar_deg (radius, phi)</code>	phi in deg	-> polar coordinates phi deg
Points		
<code>north(d)</code>	see 20.42 d distance to the point	d=1 if empty
<code>south(d)</code>		
<code>east(d)</code>		
<code>west(d)</code>		
<code>normalize()</code>	<code>z.b = z.a: normalize ()</code>	-> $z.b = 1$ and $z.a = k \times z.b$
<code>get_points (obj)</code>	retrieves points from the object	
Transformations		
<code>symmetry(obj)</code>	obj : point,line,etc.	-> <code>z.a:symmetry (C.OH)</code>
<code>rotation(angle , obj)</code>	point,line,etc.	-> rotation center a
<code>homothety(k,obj)</code>	<code>z.c = z.a : homothety (2,z.b)</code>	

7.2.1 Example: method north (d)

If d is absent then it is considered equal to 1.

```

\begin{tkzelements}
  z.O = point : new ( 0, 0 )
  z.A = z.O : east ( )
  z.Ap = z.O : east (2) : north (2)
  z.B = z.O : north ( )
  z.C = z.O : west ( )
  z.D = z.O : south ( )
\end{tkzelements}
\begin{tikzpicture}
  \tkzGetNodes
  \tkzDrawPolygon(A,B,C,D)
  \tkzDrawPoints(A,B,C,D,O,A')
\end{tikzpicture}

```

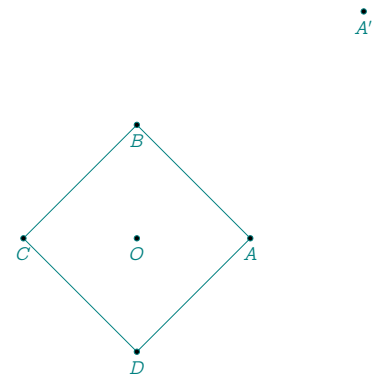

7.2.2 Example: method polar

```

\begin{tkzelements}
  z.O    = point:  new (0, 0)
  z.A    = point:  new (3, 0)
  z.F    = point:  polar (3, math.pi/3)
\end{tkzelements}
\begin{tikzpicture}
  \tkzGetNodes
  \tkzDrawCircle(O,A)
  \tkzDrawSegments[new](O,A)
  \tkzDrawSegments[purple](O,F)
  \tkzDrawPoints(A,O,F)
  \tkzLabelPoints[below right=6pt](A,O,F)
\end{tikzpicture}

```

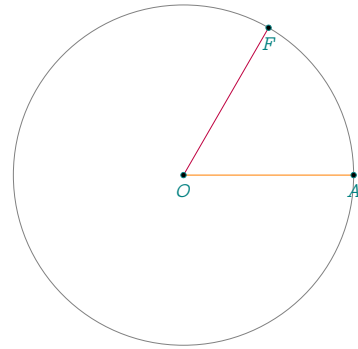

7.2.3 Example: rotation of points

```

\begin{tkzelements}
  z.a    = point:  new(0, -1)
  z.b    = point:  new(4, 0)
  z.o    = point:  new(6, -2)
  z.ap,z.bp = z.o : rotation (math.pi/2,z.a,z.b)
\end{tkzelements}
\begin{tikzpicture}
  \tkzGetNodes
  \tkzDrawLines(o,a o,a' o,b o,b')
  \tkzDrawPoints(a,a',b,b',o)
  \tkzLabelPoints(b,b',o)
  \tkzLabelPoints[below left](a,a')
  \tkzDrawArc(o,a)(a')
  \tkzDrawArc(o,b)(b')
\end{tikzpicture}

```

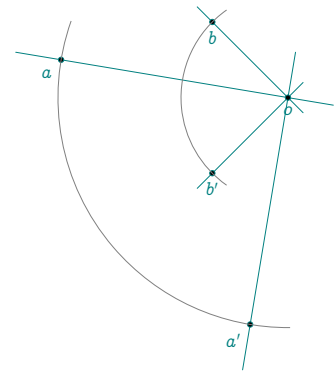

7.2.4 Object rotation

Rotate a triangle by an angle of $\pi/6$ around O .

```

\begin{tkzelements}
z.O = point : new ( -1 , -1 )
z.A = point : new ( 2 , 0 )
z.B = point : new ( 5 , 0 )
L.AB = line : new (z.A,z.B)
T.ABC = L.AB : equilateral ( )
S.fig = L.AB : square ( )
_,_,z.E,z.F = get_points ( S.fig )
S.new = z.O : rotation (math.pi/3,S.fig)
_,_,z.Ep,z.Fp = get_points ( S.new )
z.C = T.ABC.pc
T.ApBpCp = z.O : rotation (math.pi/3,T.ABC)
z.Ap,z.Bp,z.Cp = get_points ( T.ApBpCp)
\end{tkzelements}

```

```

\begin{tikzpicture}
\tkzGetNodes
\tkzDrawPolygons(A,B,C A',B',C' A,B,E,F A',B',E',F')
\tkzDrawPoints (A,B,C,A',B',C',O)
\tkzLabelPoints (A,B,C,A',B',C',O)
\tkzDrawArc[delta=0,->](O,A)(A')
\end{tikzpicture}

```

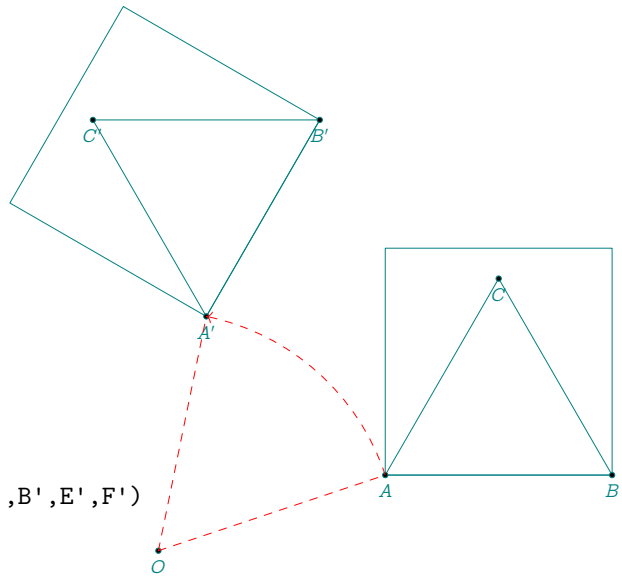

7.2.5 Object symmetry

```

\begin{tkzelements}
z.a = point: new(0,-1)
z.b = point: new(2, 0)
L.ab = line : new (z.a,z.b)
C.ab = circle : new (z.a,z.b)
z.o = point: new(1,1)
z.ap,z.bp = get_points (z.o: symmetry (C.ab))
\end{tkzelements}

```

```

\begin{tikzpicture}
\tkzGetNodes
\tkzDrawCircles(a,b a',b')
\tkzDrawLines(a,a' b,b')
\tkzDrawLines[red](a,b a',b')
\tkzDrawPoints(a,a',b,b',o)
\tkzLabelPoints(a,a',b,b',o)
\end{tikzpicture}

```

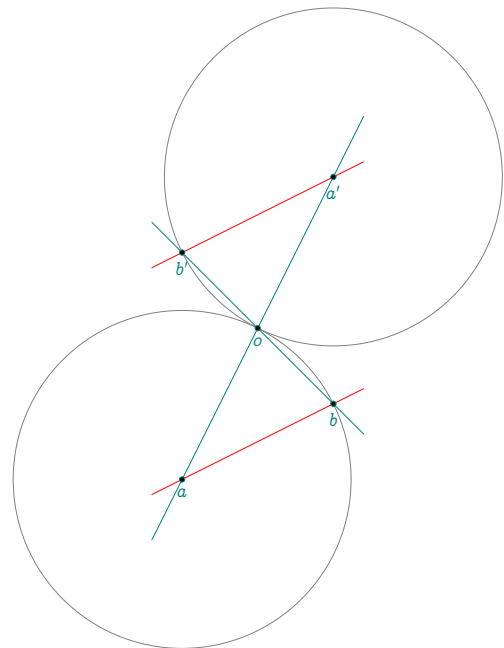

8 Class line

8.1 Attributes of a line

Writing `L.AB = line: new (z.A,z.B)` creates an object of the class `line` (the notation is arbitrary for the moment). Geometrically it is, as much, the line passing through the points A and B as the segment $[AB]$. Thus we can use the midpoint of `L.AB` which is, of course, the midpoint of the segment $[AB]$. This medium is obtained with `L.AB.mid`. Note that `L.AB.pa = z.A` and `L.AB.pb = z.B`. Finally, if a line L is the result of a method, you can obtain the points with `z.A,z.B = get_points (L)` or with the previous remark.

```
Creation L.AB = line : new ( z.A , z.B )
```

The attributes are :

Table 3: Line attributes.

Attributes	Application	
pa	First point of the segment	<code>z.A = L.AB.pa</code>
pb	Second point of the segment	
type	Type is 'line'	<code>L.AB.type = 'line'</code>
mid	Middle of the segment	<code>z.M = L.AB.mid</code>
slope	Slope of the line	obtained with <code>an = L.AB.slope</code>
length	Length of the segment	<code>l = L.AB.length</code>
north_pa	See next example	<code>d(a,north—pa)=d(a,b)=d(east,b) =etc.</code>
north_pb		
south_pa		
south_pb		
east		
west		

8.1.1 Example: attributes of class line

```
\begin{tkzelements}
  scale = .5
  z.a = point: new (1, 1)
  z.b = point: new (5, 4)
  L.ab = line : new (z.a,z.b)
  z.m = L.ab.mid
  z.w = L.ab.west
  z.e = L.ab.east
  z.r = L.ab.north_pa
  z.s = L.ab.south_pb
  sl = L.ab.slope
  len = L.ab.length
\end{tkzelements}
```

```
\begin{tikzpicture}
  \tkzGetNodes
  \tkzDrawPoints(a,b,m,e,r,s,w)
  \tkzLabelPoints(a,b,e,r,s,w)
  \tkzLabelPoints[above](m)
  \tkzDrawLine(a,b)
  \tkzLabelSegment[sloped](a,b){ab = \tkzUseLua{len}}
  \tkzLabelSegment[above=12pt,sloped](a,b){slope of (ab) = \tkzUseLua{sl}}
\end{tikzpicture}
```

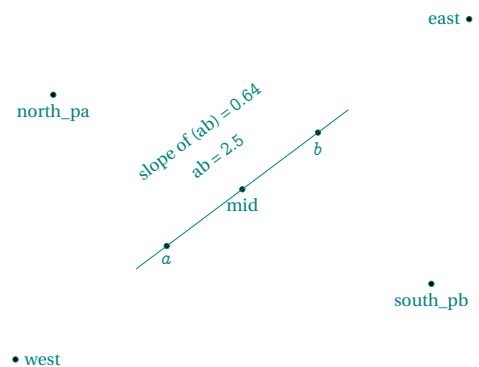

8.1.2 Method new and line attributes

Notation L or L.AB or L.euler. The notation is actually free. L.AB can also represent the segment.
 With `L.AB = line : new (z.A,z.B)`, a line is defined.

```
\begin{tkzelements}
  z.A = point : new (1,1)
  z.B = point : new (3,2)
  L.AB = line : new (z.A,z.B)
  z.C = L.AB.north_pa
  z.D = L.AB.south_pa
\end{tkzelements}
\begin{tikzpicture}
  \tkzGetNodes
  \tkzDrawLines(A,B C,D)
  \tkzDrawPoints(A,...,D)
  \tkzLabelPoints(A,...,D)
  \tkzMarkRightAngle(B,A,C)
  \tkzMarkSegments(A,C A,B A,D)
\end{tikzpicture}
```

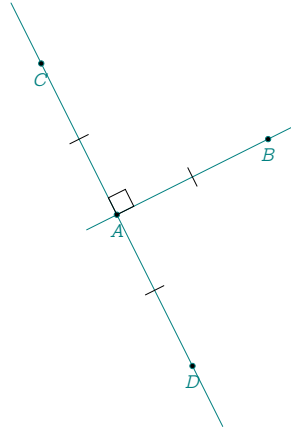

8.2 Methods of the class line

Here's the list of methods for the `line` object. The results are either reals, points, lines, circles or triangles.

8.2.1 Table of the methods from class line

Table 4: Methods of the class line.

Methods	Comments	
<code>new(A, B)</code>	<code>L.AB = line : new(z.A,z.B)</code>	line through the points A and B
Points		
<code>gold_ratio ()</code>	<code>z.C = L.AB : gold_ratio()</code>	gold ratio
<code>normalize ()</code>	<code>z.C = L.AB : normalize()</code>	$AC=1$ and $C \in (AB)$
<code>normalize_inv ()</code>	<code>z.C = L.AB : normalize_inv()</code>	$CB=1$ and $C \in (AB)$
<code>barycenter (ka,kb)</code>	<code>z.C = L.AB : barycenter (1,2) C</code>	barycenter of $\{(A,1)(B,2)\}$
<code>point (t)</code>	<code>z.C = L.AB : point (2)</code>	$\vec{AC} = 2\vec{AB}$
<code>midpoint ()</code>	<code>z.M = L.AB : midpoint ()</code>	better is <code>z.M = L.AB.mid</code>
<code>harmonic_int</code>	<code>z.D = L.AB : harmonic_int (z.C)</code>	$D \in [AB] C \notin [AB]$
<code>harmonic_ext (pt)</code>	<code>z.D = L.AB : harmonic_ext (z.C)</code>	$D \notin [AB] C \in [AB]$
<code>harmonic_both (k)</code>	<code>z.C,z.D = L.AB : harmonic_both (tkzphi)</code>	$CA/CB = DA/DB = t\phi$.
<code>square ()</code>	<code>S.AB =(L.AB : square ())</code>	create a square <code>S.AB</code> . ^a
Lines		
<code>ll_from (pt)</code>	<code>L.CD = L.AB : ll_from (z.C)</code>	$(CD) \parallel (AB)$
<code>ortho_from (pt)</code>	<code>L.CD = L.AB : ortho_from (z.C)</code>	$(CD) \perp (AB)$
<code>mediator ()</code>	<code>L.uv = L.AB : mediator ()</code>	(u,v) mediator of (A,B)
Triangles		
<code>equilateral (swap)</code>	<code>T.ABC = L.AB : equilateral ()</code>	$(\vec{AB}, \vec{AC}) > 0$
<code>isosceles (phi,swap)</code>	<code>T.ABC = L.AB : isosceles (math.pi/6)</code>	or $<$ with swap ^b
<code>gold (swap)</code>	<code>T.ABC = L.AB : gold ()</code>	right in B and $AC = \phi \times AB$
<code>euclide (swap)</code>	<code>T.ABC = L.AB : euclide ()</code>	$AB = AC$ and $(\vec{AB}, \vec{AC}) = \text{math.pi}/5$
<code>golden (swap)</code>	<code>T.ABC = L.AB : golden ()</code>	$(\vec{AB}, \vec{AC}) = 2 \times \pi/5$
Circles		
<code>circle ()</code>	<code>C.AB = L.AB : circle ()</code>	center pa through pb
<code>circle_swap ()</code>	<code>C.BA = L.AB : circle_swap ()</code>	center pb through pa
Transformations		
<code>reflection (obj)</code>	<code>new obj = L.AB : reflection (obj)</code>	
<code>translation (obj)</code>	<code>new obj = L.AB : translation (obj)</code>	
<code>projection (obj)</code>	<code>z.H = L.AB : projection (z.C)</code>	$CH \perp (AB)$ and $H \in (AB)$
Miscellaneous		
<code>distance (pt)</code>	<code>d = L.Ab : distance (z.C)</code>	see 8.2.6
<code>in_out (pt)</code>	<code>b = L.AB : in_out (z.C)</code>	b is a boolean $b=\text{true}$ if $C \in (AB)$
<code>slope ()</code>	<code>a = L.AB : slope()</code>	better is <code>L.AB.slope</code>

^a `_,_,z.C,z.D = get_points(S.AB)`

^b Triangles are defined in the direct sense of rotation, unless the "swap" option is present.

Here are a few examples.

8.2.2 Example: new line from a defined line

```

\begin{tkzelements}
  scale = 1.25
  z.A = point : new (1,1)
  z.B = point : new (3,2)
  L.AB = line : new (z.A,z.B)
  z.C = L.AB.north_pa
  z.D = L.AB.south_pa
  L.CD = line : new (z.C,z.D)
  _,z.E = get_points ( L.CD: ll_from (z.B))
  -- z.E = L2.pb
\end{tkzelements}
\begin{tikzpicture}
  \tkzGetNodes
  \tkzDrawLines(A,B C,D B,E)
  \tkzDrawPoints(A,...,E)
  \tkzLabelPoints(A,...,E)
  \tkzMarkRightAngle(B,A,C)
  \tkzMarkSegments(A,C A,B A,D)
\end{tikzpicture}

```

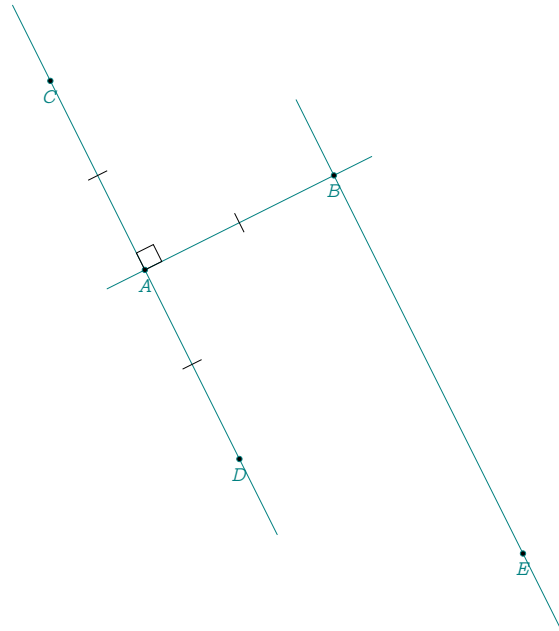

8.2.3 Example: projection of several points

```

\begin{tkzelements}
  scale = .8
  z.a = point: new (0, 0)
  z.b = point: new (4, 1)
  z.c = point: new (2, 5)
  z.d = point: new (5, 2)
  L.ab = line: new (z.a,z.b)
  z.cp,z.dp = L.ab: projection(z.c,z.d)
\end{tkzelements}
\begin{tikzpicture}
  \tkzGetNodes
  \tkzDrawLines(a,b c,c' d,d')
  \tkzDrawPoints(a,...,d,c',d')
  \tkzLabelPoints(a,...,d,c',d')
\end{tikzpicture}

```

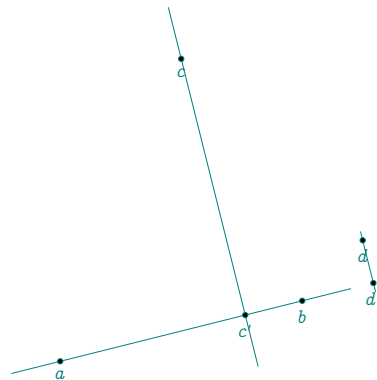

8.2.4 Example: combination of methods

```

\begin{tkzelements}
  z.A = point: new (0 , 0)
  z.B = point: new (6 , 0)
  z.C = point: new (1 , 5)
  T.ABC = triangle: new (z.A,z.B,z.C)
  L.AB = T.ABC.ab
  z.O = T.ABC.circumcenter
  C.OA = circle: new (z.O,z.A)
  z.H = L.AB: projection (z.O)
  L.ab = C.OA: tangent_at (z.A)
  z.a,z.b = L.ab.pa,L.ab.pb
  -- or z.a,z.b = get_points (L.ab)
\end{tkzelements}
\begin{tikzpicture}
  \tkzGetNodes
  \tkzDrawPolygon(A,B,C)
  \tkzDrawCircle(O,A)
  \tkzDrawSegments [purple] (O,A O,B O,H)
  \tkzDrawArc [red] (O,A) (B)
  \tkzDrawArc [blue] (O,B) (A)
  \tkzDrawLine [add = 2 and 1] (A,a)
  \tkzFillAngles [teal!30,opacity=.4] (A,C,B b,A,B A,O,H)
  \tkzMarkAngles [mark=|] (A,C,B b,A,B A,O,H H,O,B)
  \tkzDrawPoints(A,B,C,H,O)
  \tkzLabelPoints(A,B,C,H,O)
\end{tikzpicture}

```

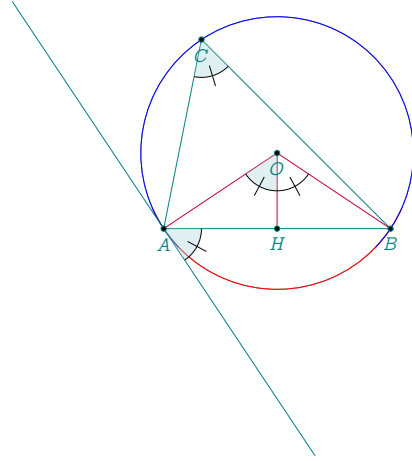

8.2.5 Example: translation

```

\begin{tkzelements}
  z.A = point: new (0,0)
  z.B = point: new (1,2)
  z.C = point: new (-3,2)
  z.D = point: new (0,2)
  L.AB = line : new (z.A,z.B)
  z.E,z.F = L.AB : translation (z.C,z.D)
\end{tkzelements}
\begin{tikzpicture}
  \tkzGetNodes
  \tkzDrawPoints(A,...,F)
  \tkzLabelPoints(A,...,F)
  \tkzDrawSegments[->,red,> =latex] (C,E D,F A,B) )
\end{tikzpicture}

```

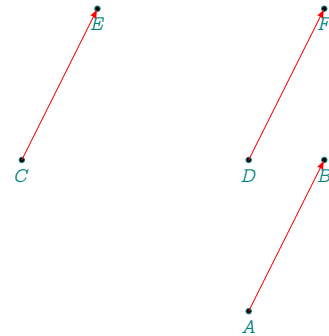

8.2.6 Example: distance and projection

```

\begin{tkzelements}
  z.A = point : new (0 , 0)
  z.B = point : new (5 , -2)
  z.C = point : new (3 , 3)
  L.AB = line : new (z.A,z.B)
  d = L.AB : distance (z.C)
  z.H = L.AB : projection (z.C)
\end{tkzelements}
\begin{tikzpicture}
  \tkzGetNodes
  \tkzDrawLines(A,B,C,H)
  \tkzDrawPoints(A,B,C,H)
  \tkzLabelPoints(A,B,C,H)
  \tkzLabelSegment[above left,
  draw](C,H){$CH = \tkzUseLua{d}$}
\end{tikzpicture}

```

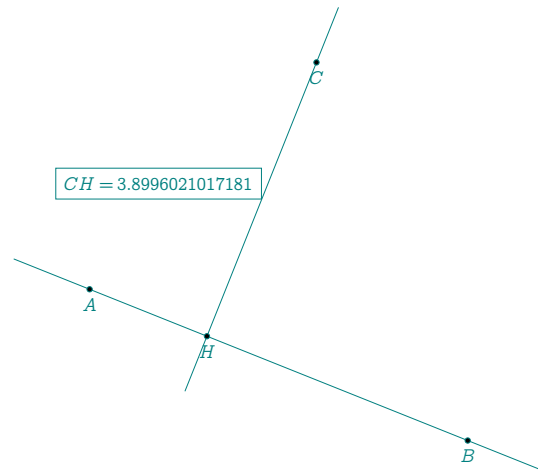

8.2.7 Reflection of object

```

\begin{tkzelements}
  z.A = point : new ( 0 , 0 )
  z.B = point : new ( 4 , 1 )
  z.E = point : new ( 0 , 2 )
  z.F = point : new ( 3 , 3 )
  z.G = point : new ( 4 , 2 )
  L.AB = line : new ( z.A , z.B )
  T.EFG = triangle : new (z.E,z.F,z.G)
  T.new = L.AB : reflection (T.EFG)
  z.Ep,z.Fp,z.Gp = get_points(T.new)
\end{tkzelements}
\begin{tikzpicture}
  \tkzGetNodes
  \tkzDrawLine(A,B)
  \tkzDrawPolygon(E,F,G)
  \tkzDrawPolygon[new] (E',F',G')
  \tkzDrawSegment[red,dashed] (E,E')
\end{tikzpicture}

```

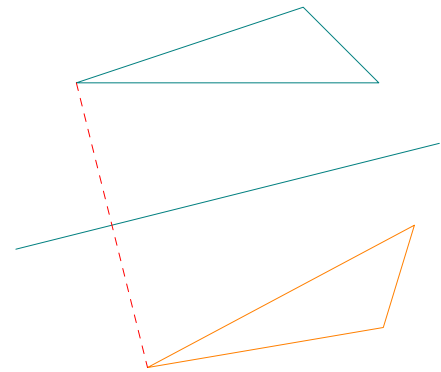

9 Class circle

9.1 Attributes of a circle

This class is also defined by two points: on the one hand, the center and on the other hand, a point through which the circle passes.

```
Creation C.OA = circle: new (z.O,z.A)
```

Table 5: Circle attributes.

Attributes	Application	
center	<code>z.A = C.AB.center</code>	
through	<code>z.B = C.AB.through</code>	
type	<code>C.AB.type</code>	-> <code>C.OA.type = 'circle'</code>
radius	<code>C.AB.radius</code>	-> <code>r = C.OA.radius</code> <i>r</i> real number
north	<code>C.AB.north</code>	-> <code>z.N = C.OA.north</code>
south	<code>C.AB.south</code>	-> <code>z.S = C.OA.south</code>
east	<code>C.AB.east</code>	-> <code>z.E = C.OA.east</code>
west	<code>C.AB.west</code>	-> <code>z.W = C.OA.west</code>

9.1.1 Example: circle attributes

Three attributes are used (south, west, radius).

```
\begin{tkzelements}
  scale = .5
  z.a = point: new (1, 1)
  z.b = point: new (5, 4)
  C.ab = circle : new (z.a,z.b)
  z.s = C.ab.south
  z.w = C.ab.west
  r = C.ab.radius
\end{tkzelements}
\begin{tikzpicture}
  \tkzGetNodes
  \tkzDrawPoints(a,b,s,w)
  \tkzLabelPoints(a,b,s,w)
  \tkzDrawCircle(a,b)
  \tkzDrawSegment(a,b)
  \tkzLabelSegment[sloped](a,b){ab = \tkzUseLua{r}}
\end{tikzpicture}
```

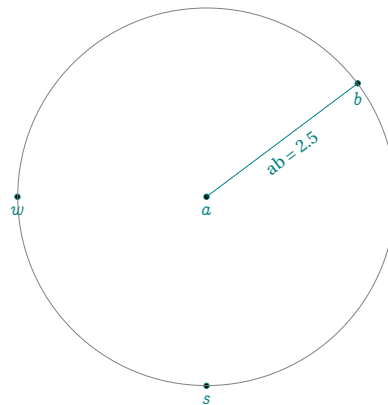

9.2 Methods of the class circle

Table 6: Circle methods.

Methods	Comments	
<code>new(O,A)</code>	<code>C.OA = circle : new (z.O,z.A)</code>	circle center O through A
<code>radius(O,r)</code>	<code>C.OA = circle : radius (z.O,2)</code>	circle center O radius =2 cm
Points		
<code>antipode (pt)</code>	<code>z.C = C.OA: antipode (z.B)</code>	$[BC]$ is a diameter
<code>inversion (pt)</code>	<code>z.Bp = C.AC: inversion (z.B)</code>	
<code>midarc (z1,z2)</code>	<code>z.D = C.AB: midarc (z.B,z.C)</code>	D is the midarc of \widehat{BC}
<code>point (t)</code>	<code>z.E = C.AB: point (0.25)</code>	t between 0 and 1
<code>random_pt(lower, upper)</code>		
<code>internal_similitude (C)</code>	<code>z.I = C.one : internal_similitude (C.two)</code>	
<code>external_similitude (C)</code>	<code>z.J = C.one : external_similitude (C.two)</code>	
Lines		
<code>radical_axis (C)</code>		
<code>tangent_at (pt)</code>	<code>z.P = C.OA: tangent_at (z.M)</code>	$((PM) \perp (OM))$
<code>tangent_from (pt)</code>	<code>z.M,z.N = C.OA: tangent_from (z.P)</code>	
<code>inversion (line)</code>	<code>L or C = C.AC: inversion (L.EF)</code>	
Circles		
<code>orthogonal_from (pt)</code>	<code>C = C.OA: orthogonal_from (z.P)</code>	
<code>orthogonal_through (pta,ptb)</code>	<code>C = C.OA: orthogonal_through (z.z1,z.z2)</code>	
<code>inversion (circle)</code>	<code>L or C = C.AC: inversion (C.EF)</code>	
Miscellaneous		
<code>power (pt)</code>	<code>p = C.OA: power (z.M)</code>	power with respect to a circle
<code>in_out (pt)</code>	<code>C.OA : in_out (z.M)</code>	boolean
<code>in_out_disk (pt)</code>	<code>C.OA : in_out_disk (z.M)</code>	boolean
<code>draw ()</code>	for further use	

9.2.1 Altshiller

```

\begin{tkzelements}
z.P = point : new (0,0)
z.Q = point : new (5,0)
z.I = point : new (3,2)
C.QI = circle : new (z.Q,z.I)
C.PE = C.QI : orthogonal_from (z.P)
z.E = C.PE.through
C.QE = circle : new (z.Q,z.E)
_,z.F = intersection (C.PE,C.QE)
z.A = C.PE: point (1/9)
L.AE = line : new (z.A,z.E)
_,z.C = intersection (L.AE,C.QE)
L.AF = line : new (z.A,z.F)
L.CQ = line : new (z.C,z.Q)
z.D = intersection (L.AF,L.CQ)
\end{tkzelements}
\begin{tikzpicture}
\tkzGetNodes
\tkzDrawCircles(P,E Q,E)
\tkzDrawLines[add=0 and 1](P,Q)
\tkzDrawLines[add=0 and 2](A,E)
\tkzDrawSegments(P,E E,F F,C A,F C,D)
\tkzDrawPoints(P,Q,E,F,A,C,D)
\tkzLabelPoints(P,Q,E,F,A,C,D)
\end{tikzpicture}

```

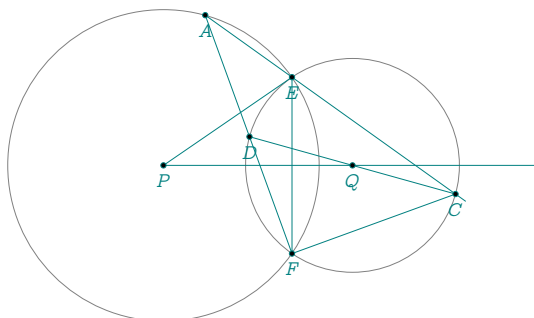

9.2.2 Lemoine

```

\begin{tkzelements}
scale = 1.6
z.A = point: new (1,0)
z.B = point: new (5,2)
z.C = point: new (1.2,2)
T = triangle: new(z.A,z.B,z.C)
z.O = T.circumcenter
C.OA = circle: new (z.O,z.A)
L.tA = C.OA: tangent_at (z.A)
L.tB = C.OA: tangent_at (z.B)
L.tC = C.OA: tangent_at (z.C)
z.P = intersection (L.tA,T.bc)
z.Q = intersection (L.tB,T.ca)
z.R = intersection (L.tC,T.ab)
\end{tkzelements}
\begin{tikzpicture}
\tkzGetNodes
\tkzDrawPolygon[teal](A,B,C)
\tkzDrawCircle(O,A)
\tkzDrawPoints(A,B,C,P,Q,R)
\tkzLabelPoints(A,B,C,P,Q,R)
\tkzDrawLine[blue](Q,R)
\tkzDrawLines[red](A,P B,Q R,C)
\tkzDrawSegments(A,R C,P C,Q)
\end{tikzpicture}

```

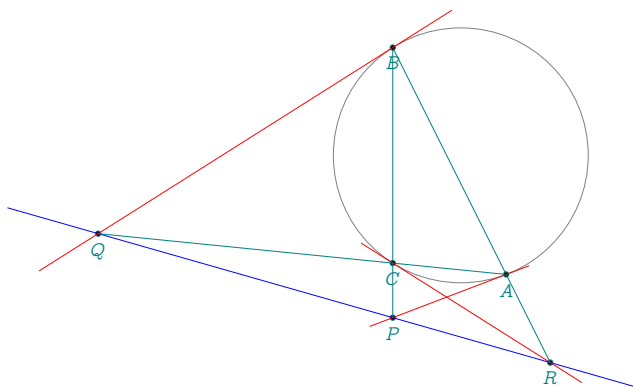

9.2.3 Inversion: point, line and circle

The "inversion" method can be used on a point, a line or a circle. Depending on the type of object, the function determines the correct algorithm to use.

9.2.4 Inversion: point

The "inversion" method can be used on a point, a line or a circle. Depending on the type of object, the function determines the correct algorithm to use.

```
\begin{tkzelements}
  z.o = point:   new (-1,2)
  z.a = point:   new (2,1)
  C.oa = circle: new (z.o,z.a)
  z.c = point:   new (3,4)
  z.d = C.oa:    inversion (z.c)
  p    = C.oa:   power (z.c)
\end{tkzelements}
\begin{tikzpicture}
  \tkzGetNodes
  \tkzDrawCircle(o,a)
  \tkzDrawSegments(o,a o,c)
  \tkzDrawPoints(a,o,c,d)
  \tkzLabelPoints(a,o,c,d)
  \tkzLabelSegment[sloped,above=1em](c,d){%
    Power of c with respect to C is \tkzUseLua{p}}
\end{tikzpicture}
```

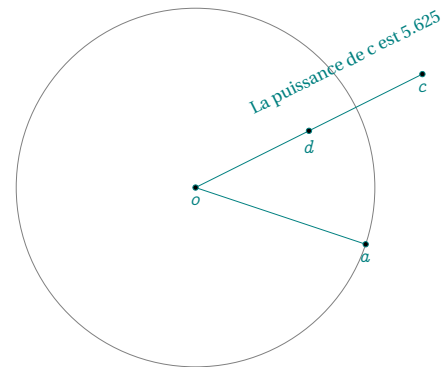

9.2.5 Inversion: line

The result is either a straight line or a circle.

```
\begin{tkzelements}
  z.o = point:   new (-1,1)
  z.a = point:   new (1,3)
  C.oa = circle: new (z.o,z.a)
  z.c = point:   new (3,2)
  z.d = point:   new (0,4)
  L.cd = line:    new (z.c,z.d)
  C.OH = C.oa:   inversion (L.cd)
  z.O,z.H = get_points(C.OH)
\end{tkzelements}
\begin{tikzpicture}
  \tkzGetNodes
  \tkzDrawCircles(o,a O,H)
  \tkzDrawLines(c,d o,H)
  \tkzDrawPoints(a,o,c,d,H)
  \tkzLabelPoints(a,o,c,d,H)
\end{tikzpicture}
```

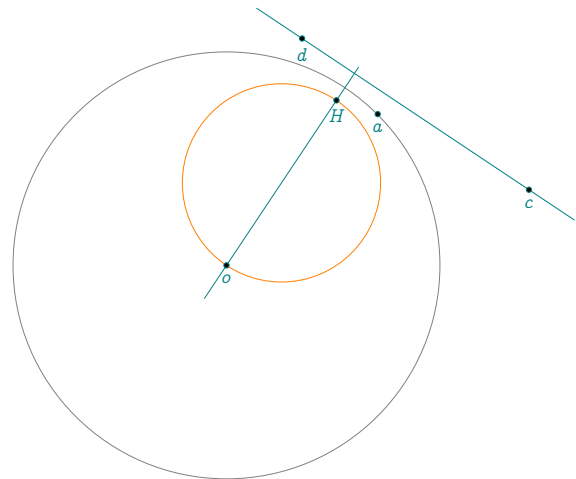

9.2.6 Inversion: circle

The result is either a straight line or a circle.

```

\begin{tkzelements}
scale = .7
z.o,z.a = point: new (-1,3),point: new (2,3)
z.c      = point: new (-2,1)
z.e,z.d = point: new (-2,7),point: new (-3,5)
C.oa     = circle: new (z.o,z.a)
C.ed     = circle: new (z.e,z.d)
C.co     = circle: new (z.c,z.o)
obj      = C.oa: inversion (C.co)
  if obj.type == "line"
    then z.p,z.q = get_points(obj)
    else z.f,z.b = get_points(obj) end
obj      = C.oa: inversion(C.ed)
  if obj.type == "line"
    then z.p,z.q = get_points(obj)
    else z.f,z.b = get_points(obj) end
color = "orange"
\end{tkzelements}
\begin{tikzpicture}
\tkzGetNodes
\tkzDrawCircles[black](o,a)
\tkzDrawCircles[teal](c,o e,d)
\tkzDrawCircles[\tkzUseLua{color}](f,b)
\tkzDrawLines[\tkzUseLua{color}](p,q)
\tkzDrawPoints(a,...,f,o,p,q)
\tkzLabelPoints(a,...,f,o,p,q)
\end{tikzpicture}

```

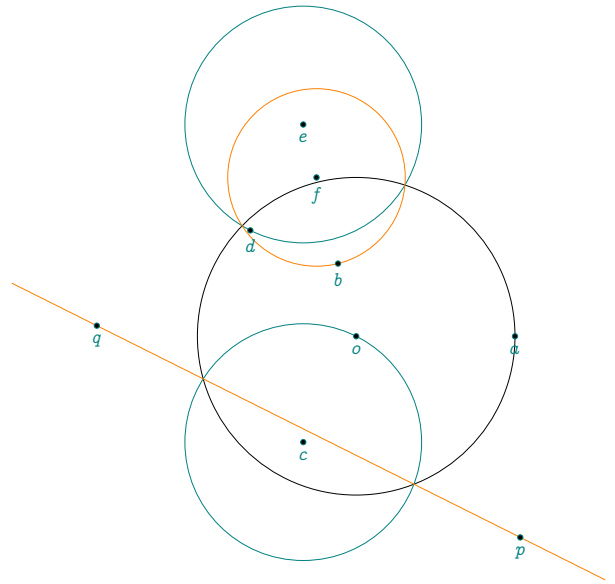

10 Classe triangle

10.1 Attributes of a triangle

The triangle object is created using the new method, for example with

```
Creation T.ABC = triangle : new ( z.A , z.B , z.C )
```

(See examples: 20.3; 20.4; 20.8). Multiple attributes are then created.

Table 7: Triangle attributes.

Attributes	Application
pa	T.ABC.pa
pb	T.ABC.pb
pc	T.ABC.pc
type	'triangle'
circumcenter	T.ABC.circumcenter
centroid	T.ABC.centroid
incenter	T.ABC.incenter
orthocenter	T.ABC.orthocenter
eulercenter	T.ABC.eulercenter
spiekercenter	T.ABC.spiekercenter
a	It's the length of the side opposite the first vertex
b	It's the length of the side opposite the second vertex
c	It's the length of the side opposite the third vertex
alpha	Vertex angle of the first vertex
beta	Vertex angle of the second vertex
gamma	Vertex angle of the third vertex
ab	Line defined by the first two points of the triangle
ac	Line defined by the first point and the last point
bc	Line defined by the last two points of the triangle

10.1.1 Example: triangle attributes

```

\begin{tkzelements}
  z.a = point: new (0 , 0)
  z.b = point: new (4 , 0)
  z.c = point: new (0 , 3)
  T.abc = triangle : new (z.a,z.b,z.c)
  z.O = T.abc.circumcenter
  z.I = T.abc.incenter
  z.H = T.abc.orthocenter
  z.G = T.abc.centroid
  a = T.abc.a
  b = T.abc.b
  c = T.abc.c
  alpha = T.abc.alpha
  beta = T.abc.beta
  gamma = T.abc.gamma
\end{tkzelements}
\begin{tikzpicture}
  \tkzGetNodes
  \tkzDrawPolygon(a,b,c)
  \tkzDrawPoints(a,b,c,O,G,I,H)
  \tkzLabelPoints(a,b,c,O,G,I)
  \tkzLabelPoints[above right] (H)
  \tkzDrawCircles(O,a)
  \tkzLabelSegment[sloped] (a,b){\tkzUseLua{c}}
  \tkzLabelSegment[sloped,above] (b,c){\tkzUseLua{a}}
\end{tikzpicture}

```

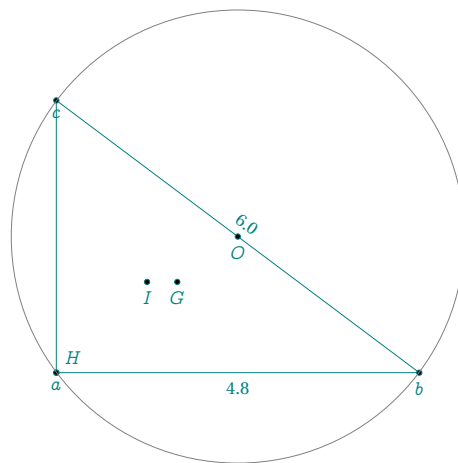

10.2 Methods of the class triangle

Table 8: triangle methods.

Methods	Comments
<code>new (a, b, c)</code>	<code>T.ABC = triangle : new (z.A, z.B, z.C)</code>
...	T or T.name with what you want for name, is possible.
Points	
<code>lemoine_point ()</code>	<code>T.ABC : lemoine_point ()</code> intersection os the symmedians
<code>symmedian_point ()</code>	Lemoine point or the Grebe point
<code>bevan_point ()</code>	Circumcenter of the excentral triangle
<code>mittenpunkt_point ()</code>	Symmedian point of the excentral triangle
<code>gergonne_point ()</code>	Intersection of the three cevians that lead to the contact points
<code>nagel_point ()</code>	Intersection of the three cevians that lead to the extouch points
<code>feuerbach_point ()</code>	The point at which the incircle and euler circle are tangent.
<code>spieker_center ()</code>	Incenter of the medial triangle
<code>barycenter (ka, kb, kc)</code>	<code>T.ABC: barycenter (2, 1, 1)</code> barycenter of $(\{A, 2\}, \{B, 1\}, \{C, 1\})$
<code>base (u, v)</code>	<code>z.D = T.ABC: base(1, 1)</code> \rightarrow ABDC is a parallelogram
<code>projection (p)</code>	Projection of a point on the sides
<code>euler_points ()</code>	Euler points of euler circle
<code>nine_points ()</code>	9 Points of the euler circle
<code>parallelogram ()</code>	<code>z.D = T.ABC : parallelogram ()</code> \rightarrow ABCD is a parallelogram
Lines	
<code>altitude (n)</code>	<code>L.AHa = T.ABC : altitude ()</code> n empty or 0 line from A^a
<code>bisector (n)</code>	<code>L.Bb = T.ABC : bisector (1)</code> n = 1 line from B^b
<code>bisector_ext(n)</code>	n=2 line from the third vertex.
<code>symmedian_line (n)</code>	Cevian with respect to Lemoine point.
<code>euler_line ()</code>	the line through N, G, H and O if the triangle is not equilateral ^c
<code>antiparallel(pt, n)</code>	n=0 antiparallel through pt to (BC) , n=1 to (AC) etc.

^a `z.Ha = L.AHa.pb` recovers the common point of the opposite side and altitude. The method `orthic` is usefull.

^b `_, z.b = get_points(L.Bb)` recovers the common point of the opposite side and bisector.

^c N center of nine points circle, G centroid, H orthocenter, O circum center

Methods	Comments
Circles	
euler_circle ()	C.NP = T.ABC : euler_circle () -> N euler point ^a
circum_circle ()	C.OA = T.ABC : circum () Triangle's circumscribed circle
in_circle ()	Inscribed circle of the triangle
ex_circle (n)	Circle tangent to the three sides of the triangle ; n=1 swap ; n=2 2 swap
first_lemoine_circle ()	The center is the midpoint between Lemoine point and the circumcenter. ^b
second_lemoine_circle ()	see example 20.57
spieker_circle ()	The incircle of the medial triangle
Triangles	
orthic ()	T = T.ABC : orthic () triangle joining the feet of the altitudes
medial ()	T = T.ABC : medial () triangle with vertices at the midpoints
incentral ()	Cevian triangle of the triangle with respect to its incenter
excentral ()	Triangle with vertices corresponding to the excenters
extouch ()	Triangle formed by the points of tangency with the excircles
intouch ()	Contact triangle formed by the points of tangency of the incircle
tangential ()	Triangle formed by the lines tangent to the circumcircle at the vertices
feuerbach ()	Triangle formed by the points of tangency of the euler circle with the excircles
anti ()	Anticomplementary Triangle The given triangle is its medial triangle.
cevia (pt)	Triangle formed with the endpoints of the three cevians with respect to pt.
symmedian ()	Triangle formed with the intersection points of the symmedians.
euler ()	Triangle formed with the euler points
Miscellaneous	
area ()	$\mathcal{A} = T.ABC$: area ()
barycentric_coordinates (pt)	Triples of numbers corresponding to masses placed at the vertices
in_out (pt)	Boolean. Test if pt is inside the triangle
check_equilateral ()	Boolean. Test if the triangle is equilateral

^a The midpoint of each side of the triangle, the foot of each altitude, the midpoint of the line segment from each vertex of the triangle to the orthocenter.

^b Through the Lemoine point draw lines parallel to the triangle's sides. The points where the parallel lines intersect the sides of ABC then lie on a circle known as the first Lemoine circle.

10.2.1 Euler line

```

\begin{tkzelements}
  z.A      = point: new (0 , 0)
  z.B      = point: new (6 , 0)
  z.C      = point: new (1.5 , 3.5)
  T.ABC    = triangle: new (z.A,z.B,z.C)
  z.O      = T.ABC.circumcenter
  z.G      = T.ABC.centroid
  z.N      = T.ABC.eulercenter
  z.H      = T.ABC.orthocenter
  z.P,z.Q,z.R = get_points (T.ABC: orthic())
  z.K,z.I,z.J = get_points (T.ABC: medial ())
\end{tkzelements}
\begin{tikzpicture}
  \tkzGetNodes
  \tkzDrawLines[blue](O,H)
  \tkzDrawCircle[red](N,I)
  \tkzDrawCircles[teal](O,A)
  \tkzDrawSegments(A,P B,Q C,R)
  \tkzDrawSegments[red](A,I B,J C,K)

```

```

\tkzDrawPolygons(A,B,C)
\tkzDrawPoints(A,B,C,N,I,J,K,O,P,Q,R,H,G)
\tkzLabelPoints(A,B,C,I,J,K,P,Q,R,H)
\tkzLabelPoints[below](N,O,G)
\end{tikzpicture}

```

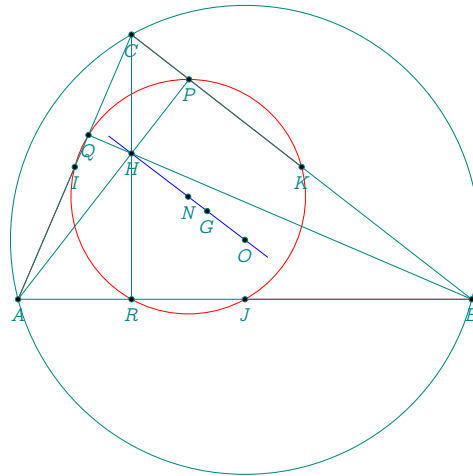

10.3 Harmonic division and bisector

```

\begin{tkzelements}
  scale = .75
  z.A = point: new (0 , 0)
  z.B = point: new (6 , 0)
  z.M = point: new (5 , 4)
  T.AMB = triangle : new (z.A,z.M,z.B)
  L.AB = T.AMB.ca
  L.bis = T.AMB : bisector (1)
  z.C = L.bis.pb
  L.bisext = T.AMB : bisector_ext (1)
  z.D = intersection (L.bisext,L.AB)
  L.CD = line: new (z.C,z.D)
  z.O = L.CD.mid
  L.AM = line: new (z.A,z.M)
  L.LL = L.AM : ll_from (z.B)
  L.MC = line: new (z.M,z.C)
  L.MD = line: new (z.M,z.D)
  z.E = intersection (L.LL,L.MC)
  z.F = intersection (L.LL,L.MD)
\end{tkzelements}
\begin{tikzpicture}
  \tkzGetNodes
  \tkzDrawPolygon(A,B,M)
  \tkzDrawCircle[purple](O,C)
  \tkzDrawSegments[purple](M,E M,D E,F)
  \tkzDrawSegments(D,B)
  \tkzDrawPoints(A,B,M,C,D,E,F)
  \tkzLabelPoints[below right](A,B,C,D,E)
  \tkzLabelPoints[above](M,F)
  \tkzFillAngles[opacity=.4,cyan!20](A,M,B B,E,M)
  \tkzFillAngles[opacity=.4,purple!20](B,M,F M,F,B)
\end{tikzpicture}

```

```

\tkzMarkRightAngle[opacity=.4,fill=gray!20](C,M,D)
\tkzMarkAngles[mark=| |](A,M,E E,M,B B,E,M)
\tkzMarkAngles[mark=|](B,M,F M,F,B)
\tkzMarkSegments(B,E B,M B,F)
\end{tikzpicture}

```

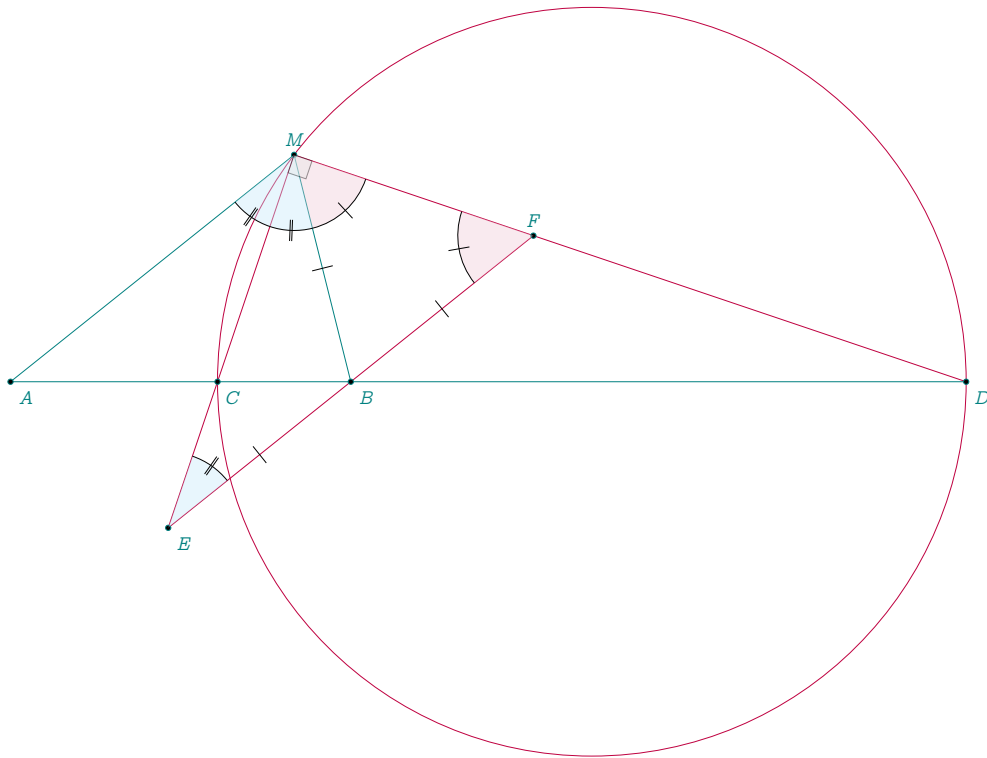

11 Classe ellipse

11.1 Attributes of an ellipse

The first attributes are the three points that define the ellipse : `center` , `vertex` and `covertex`. The first method to define an ellipse is to give its center, then the point named `vertex` which defines the major axis and finally the point named `covertex` which defines the minor axis.

Table 9: Ellipse attributes.

Attributes	Application
<code>center</code>	center of the ellipse
<code>vertex</code>	point of the major axis and of the ellipse
<code>covertex</code>	point of the minor axis and of the ellipse
<code>type</code>	The type is 'ellipse'
<code>Rx</code>	Radius from center to vertex
<code>Ry</code>	Radius from center to covertex
<code>slope</code>	Slope of the line passes through the foci
<code>Fa</code>	First focus
<code>Fb</code>	Second focus
<code>south</code>	See next example 11.1.1
<code>north</code>	
<code>west</code>	
<code>east</code>	

11.1.1 Attributes of an ellipse: example

```

\begin{tkzelements}
  z.C = point: new (3 , 2)
  z.A = point: new (5 , 1)
  L.CA = line : new (z.C,z.A)
  z.b = L.CA.north_pa
  L = line : new (z.C,z.b)
  z.B = L : point (0.5)
  E = ellipse: new (z.C,z.A,z.B)
  a = E.Rx
  b = E.Ry
  z.F1 = E.Fa
  z.F2 = E.Fb
  slope = math.deg(E.slope)
  z.E = E.east
  z.N = E.north
  z.W = E.west
  z.S = E.south
  z.Co = E.covertex
  z.Ve = E.vertex
\end{tkzelements}
\begin{tikzpicture}
  \pgfkeys{/pgf/number format/.cd,fixed,precision=2}
  \tkzGetNodes
  \tkzDrawCircles[teal](C,A)
  \tkzDrawEllipse[red](C,\tkzUseLua{a},\tkzUseLua{b},
  \tkzUseLua{slope})
  \tkzDrawPoints(C,A,B,b,W,S,F1,F2)
  \tkzLabelPoints(C,A,B)
  \tkzDrawLine[add = .5 and .5](A,W)

```

```

\tkzLabelSegment[pos=1.5,above,sloped](A,W){%
  slope = \pgfmathprintnumber{\tkzUseLua{slope}}
\tkzLabelPoint[below](S){South}
\tkzLabelPoint[below left](F1){Focus 1}
\tkzLabelPoint[below left](F2){Focus 2}
\tkzLabelPoint[above right](Ve){Vertex ; East}
\tkzLabelPoint[above right](Co){Covertex ; North}
\end{tikzpicture}

```

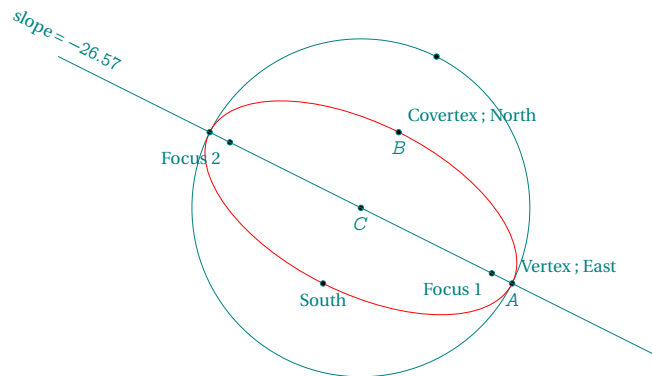

11.2 Methods of the class ellipse

Before reviewing the methods and functions related to ellipses, let's take a look at how you can draw ellipses with `tkz-elements`. The `\tkzDrawEllipse` macro requires 4 arguments: the center of the ellipse, the long radius (on the focus axis), the short radius and the angle formed by the focus axis. The last three arguments must be transferred from `tkzelements` to `tikzpicture`. To do this, you'll need to use a `tkz-elements` function: `set_lua_to_tex`. See 17 or the next examples.

☞ You need to proceed with care, because unfortunately at the moment, the macros you create are global and you can overwrite existing macros. One solution is either to choose a macro name that won't cause any problems, or to save the initial macro.

Table 10: Ellipse methods.

Methods	Example
<code>new (pc, pa ,pb)</code>	<code>E = ellipse: new (center, vertex, covertex)</code>
<code>foci (f1,f2,v)</code>	<code>E = ellipse: foci (focus 1, focus 2, vertex)</code>
<code>radii (c,a,b,sl)</code>	<code>E = ellipse: radii (center, radius a, radius b, slope)</code>
<code>in_out (pt)</code>	pt in/out of the ellipse
<code>tangent_at (pt)</code>	see example 11.2.3
<code>tangent_from (pt)</code>	see example 11.2.3
<code>point (t)</code>	vertex = point (0) covertex = point (0.25) ex see 11.2.3

11.2.1 Method new

The main method for creating a new ellipse is `new`. The arguments are three: center, vertex and covertex For attributes see 11

```

\begin{tkzelements}
  z.C      = point: new (3 , 2)
  z.A      = point: new (5 , 1)
  z.B      = z.C : homothety(0.5,
    z.C : rotation (math.pi/2,z.A))
  E        = ellipse: new (z.C,z.A,z.B)
  a        = E.Rx
  b        = E.Ry
  slope    = math.deg(E.slope)
\end{tkzelements}
\begin{tikzpicture}
  \tkzGetNodes
  \tkzDrawCircles[teal](C,A)
  \tkzDrawEllipse[red](C,\tkzUseLua{a},
    \tkzUseLua{b},\tkzUseLua{slope})
  \tkzDrawPoints(C,A,B)
  \tkzLabelPoints(C,A,B)
\end{tikzpicture}

```

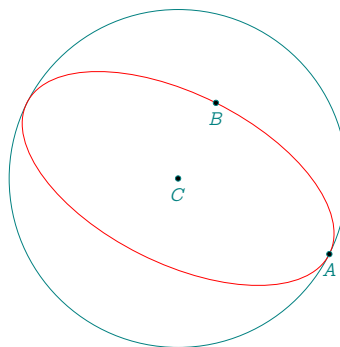

The function `set_lua_to_tex (list)` is used to define the macros that will be used to draw the ellipse with TikZ or tkz-euclide.

11.2.2 Method foci

The first two points are the foci of the ellipse. The third one is the vertex. We can deduce all the other characteristics.

The function launches the new method, all the characteristics of the ellipse are defined.

```

\begin{tkzelements}
  z.A      = point: new (0 , 0)
  z.B      = point: new (5 , 1)
  L.AB     = line : new (z.A,z.B)
  z.C      = point: new (.8 , 3)
  T.ABC    = triangle: new (z.A,z.B,z.C)
  z.N      = T.ABC.eulercenter
  z.H      = T.ABC.orthocenter
  z.O      = T.ABC.circumcenter
  _,_,z.Mc = get_points (T.ABC: medial ())
  L.euler  = line: new (z.H,z.O)
  C.circum = circle: new (z.O,z.A)
  C.euler  = circle: new (z.N,z.Mc)
  z.i,z.j  = intersection (L.euler,C.circum)
  z.I,z.J  = intersection (L.euler,C.euler)
  E        = ellipse: foci (z.H,z.O,z.I)
  L.AH     = line: new (z.A,z.H)
  z.X      = intersection (L.AH,C.circum)
  L.XO     = line: new (z.X,z.O)
  z.R,z.S  = intersection (L.XO,E)
  a,b     = E.Rx,E.Ry
  ang     = math.deg(E.slope)
\end{tkzelements}

```

```

\begin{tikzpicture}
  \tkzGetNodes
  \tkzDrawPolygon(A,B,C)
  \tkzDrawCircles[cyan](O,A N,I)
  \tkzDrawSegments(X,R A,X)
  \tkzDrawEllipse[red](N,\tkzUseLua{a},
    \tkzUseLua{b},\tkzUseLua{ang})
  \tkzDrawLines[add=.2 and .5](I,H)
  \tkzDrawPoints(A,B,C,N,O,X,H,R,S,I)
  \tkzLabelPoints[above](C,X)
  \tkzLabelPoints[above right](N,O)
  \tkzLabelPoints[above left](R)
  \tkzLabelPoints[left](A)
  \tkzLabelPoints[right](B,I,S,H)
\end{tikzpicture}

```

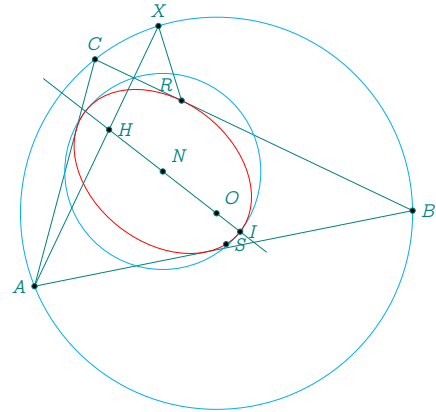

11.2.3 Method point and radii

The method point defines a point M of the ellipse whose coordinates are $(a \times \cos(\phi), b \times \sin(\phi))$. ϕ angle between (center,vertex) and (center, M)

The environment `tkzelements` uses as lua the radian as unit for angles.

```

\begin{tkzelements}
  z.C      = point: new (2 , 3)
  z.A      = point: new (6 , 5)
  a        = value(4)
  b        = value(3)
  ang      = math.deg(-math.pi/4)
  E        = ellipse: radii (z.C,a,b,-math.pi/4)
  z.V      = E : point (0)
  z.K      = E : point (1)
  z.CoV    = E : point (0.25)
  z.X      = E : point (0.5)
  L        = E :tangent_at (z.V)
  z.x,z.y  = get_points(L)
  L.ta,L.tb = E :tangent_from (z.A)
  z.M      = L.ta.pb
  z.N      = L.tb.pb
  L.K      = E :tangent_at (z.K)
  z.ka,z.kb = get_points(L.K)
\end{tkzelements}

```

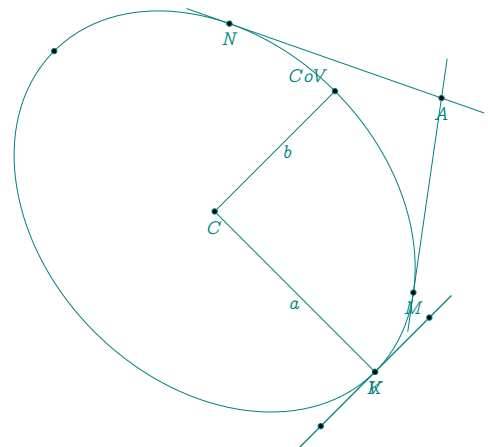

```

\begin{tikzpicture}
  \tkzGetNodes
  \tkzDrawSegments(C,V C,CoV)
  \tkzDrawLines(x,y A,M A,N ka,kb)
  \tkzLabelSegment(C,V){$a$}
  \tkzLabelSegment[right](C,CoV){$b$}
  \tkzDrawEllipse[teal](C,\tkzUseLua{a},\tkzUseLua{b},\tkzUseLua{ang})
  \tkzDrawPoints(C,V,CoV,X,x,y,M,N,A,K)
  \tkzLabelPoints(C,V,A,M,N,K)
  \tkzLabelPoints[above left](CoV)
\end{tikzpicture}

```

12 Classe Quadrilateral

12.1 Quadrilateral Attributes

Points are created in the direct direction. A test is performed to check whether the points form a rectangle, otherwise compilation is blocked.

```
Creation Q.new = rectangle : new (z.A,z.B,z.C,z.D)
```

Table 11: rectangle attributes.

Attributes	Application	
pa	z.A = Q.new.pa	
pb	z.B = Q.new.pb	
pc	z.C = Q.new.pc	
pd	z.D = Q.new.pd	
type	Q.new.type= 'quadrilateral'	
i	z.I = Q.new.i	intersection of diagonals
g	z.G = Q.new.g	barycenter
a	AB = Q.new.a	barycenter
b	BC = Q.new.b	barycenter
c	CD = Q.new.c	barycenter
d	DA = Q.new.d	barycenter
ab	Q.new.ab	line passing through two vertices
ac	Q.new.ca	idem.
ad	Q.new.ad	idem.
bc	Q.new.bc	idem.
bd	Q.new.bd	idem.
cd	Q.new.cd	idem.

12.1.1 Quadrilateral attributes

```
\begin{tkzelements}
z.A      = point : new ( 0 , 0 )
z.B      = point : new ( 4 , 0 )
z.C      = point : new ( 5 , 1 )
z.D      = point : new ( -1 , 4 )
Q.ABCD   = quadrilateral : new ( z.A , z.B , z.C , z.D )
z.I      = Q.ABCD.i
z.G      = Q.ABCD.g
\end{tkzelements}

\begin{tikzpicture}
\tkzGetNodes
\tkzDrawPolygon(A,B,C,D)
\tkzDrawSegments(A,C B,D)
\tkzDrawPoints(A,B,C,D,I,G)
\end{tikzpicture}
```

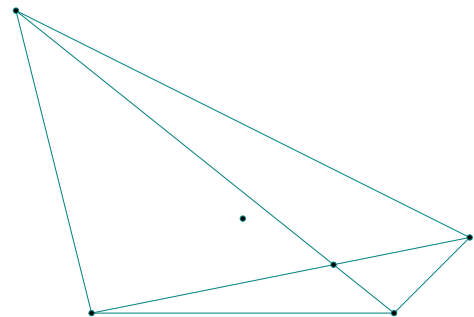

12.2 Quadrilateral methods

Table 12: Quadrilateral methods.

Methods	Comments
iscyclic ()	inscribed ? (see next example)

12.2.1 Inscribed quadrilateral

```

\begin{tkzelements}
z.A      = point : new ( 0 , 0 )
z.B      = point : new ( 4 , 0 )
z.D      = point : polar ( 4 , 2*math.pi/3 )
L.DB     = line : new (z.D,z.B)
T.equ    = L.DB : equilateral ()
z.C      = T.equ.pc
Q.new    = quadrilateral : new (z.A,z.B,z.C,z.D)
bool     = Q.new : iscyclic ()
if bool == true then
C.cir    = triangle : new (z.A,z.B,z.C): circum_circle ()
z.O      = C.cir.center
end
\end{tkzelements}

\begin{tikzpicture}
\tkzGetNodes
\tkzDrawPolygon(A,B,C,D)
\tkzDrawPoints(A,B,C,D)
\tkzLabelPoints(A,B,C,D)
\tkzDrawCircle(O,A)
\ifthenelse{\equal{\tkzUseLua{bool}}{true}}{
\tkzDrawCircle(O,A)}{}
\end{tikzpicture}

```

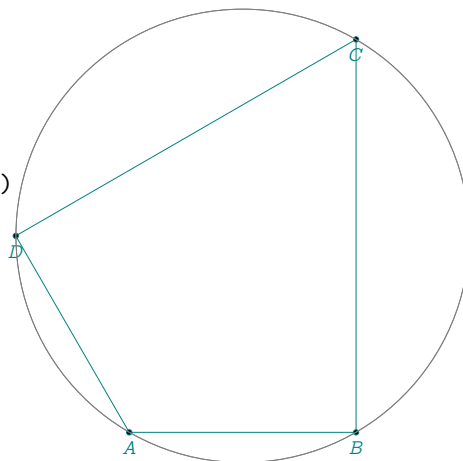

13 Classe square

13.1 Square attributes

Points are created in the direct direction. A test is performed to check whether the points form a square, otherwise compilation is blocked.

```
Creation S.AB = square : new (z.A,z.B,z.C,z.D)
```

Table 13: Square attributes.

Attributes	Application	
pa	<code>z.A = S.AB.pa</code>	
pb	<code>z.B = S.AB.pb</code>	
pc	<code>z.C = S.AB.pc</code>	
pd	<code>z.D = S.AB.pd</code>	
type	<code>S.AB.type= 'square'</code>	
side	<code>s = S.AB.center</code>	s = length of side
center	<code>z.I = S.AB.center</code>	center of the square
extradius	<code>S.AB.exradius</code>	radius of the circumscribed circle
inradius	<code>S.AB.inradius</code>	radius of the inscribed circle
proj	<code>S.AB.proj</code>	projection of the center on one side
ab	<code>S.AB.ab</code>	line passing through two vertices
ac	<code>S.AB.ca</code>	idem.
ad	<code>S.AB.ad</code>	idem.
bc	<code>S.AB.bc</code>	idem.
bd	<code>S.AB.bd</code>	idem.
cd	<code>S.AB.cd</code>	idem.

13.1.1 Example: square attributes

```
\begin{tkzelements}
z.A      = point  : new ( 0 , 0 )
z.B      = point  : new ( 4 , 0 )
z.C      = point  : new ( 4 , 4 )
z.D      = point  : new ( 0 , 4 )
S.new    = square : new ( z.A , z.B ,z.C,z.D)
z.I      = S.new.center
z.H      = S.new.proj
\end{tkzelements}
\begin{tikzpicture}
\tkzGetNodes
\tkzDrawCircles[orange] (I,A I,H)
\tkzDrawPolygon(A,B,C,D)
\tkzDrawPoints(A,B,C,D,H,I)
\tkzLabelPoints(A,B,H,I)
\tkzLabelPoints[above] (C,D)
\tkzDrawSegments(I,B I,H)
\tkzLabelSegment[sloped] (I,B){\pmpn{\tkzUseLua{S.new.exradius}}}
\tkzLabelSegment[sloped] (I,H){\pmpn{\tkzUseLua{S.new.inradius}}}
\tkzLabelSegment[sloped] (D,C){\pmpn{\tkzUseLua{S.new.side}}}
\end{tikzpicture}
```

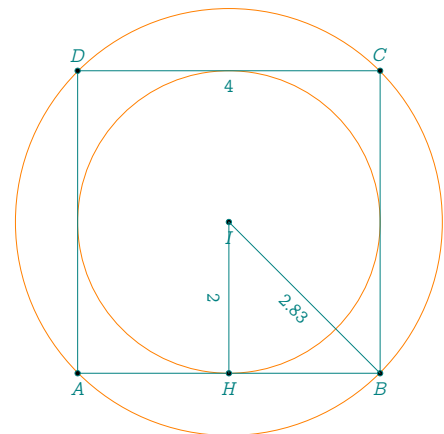

13.2 Square methods

Table 14: Square methods.

Methods	Comments
rotation (zi,za)	S.IA = square : rotation (z.I,z.A) <i>I</i> square center <i>A</i> first vertex
side (za,zb)	S.AB = square : side (z.A,z.B) AB is the first side (direct)

13.2.1 Square with side method

```

\begin{tkzelements}
  scale      = 2
  z.A        = point : new ( 0 , 0 )
  z.B        = point : new ( 2 , 1 )
  S.side     = square : side (z.A,z.B)
  z.B        = S.side.pb
  z.C        = S.side.pc
  z.D        = S.side.pd
  z.I        = S.side.center
\end{tkzelements}

```

```

\begin{tikzpicture}
  \tkzGetNodes
  \tkzDrawPolygon(A,B,C,D)
  \tkzDrawPoints(A,B,C,D)
  \tkzLabelPoints(A,B)
  \tkzLabelPoints[above](C,D)
  \tkzDrawPoints[red](I)
\end{tikzpicture}

```

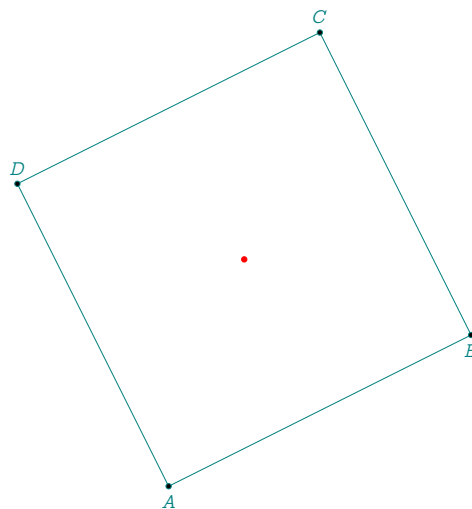

14 Classe rectangle

14.1 Rectangle attributes

Points are created in the direct direction. A test is performed to check whether the points form a rectangle, otherwise compilation is blocked.

```
Creation R.ABCD = rectangle : new (z.A,z.B,z.C,z.D)
```

Table 15: rectangle attributes.

Attributes	Application	
pa	z.A = R.ABCD.pa	
pb	z.B = R.ABCD.pb	
pc	z.C = R.ABCD.pc	
pd	z.D = R.ABCD.pd	
type	R.ABCD.type= 'rectangle'	
center	z.I = R.ABCD.center	center of the rectangle
length	R.ABCD.length	the length
width	R.ABCD.width	the width
diagonal	R.ABCD.diagonal	diagonal length
ab	R.ABCD.ab	line passing through two vertices
ac	R.ABCD.ca	idem.
ad	R.ABCD.ad	idem.
bc	R.ABCD.bc	idem.
bd	R.ABCD.bd	idem.
cd	R.ABCD.cd	idem.

14.1.1 Example

```
\begin{tkzelements}
z.A = point : new ( 0 , 0 )
z.B = point : new ( 4 , 0 )
z.C = point : new ( 4 , 4 )
z.D = point : new ( 0 , 4 )
R.new = rectangle : new (z.A,z.B,z.C,z.D)
z.I = R.new.center
\end{tkzelements}
```

```
\begin{tikzpicture}
\tkzGetNodes
\tkzDrawPolygon(A,B,C,D)
\tkzDrawPoints(A,B,C,D)
\tkzLabelPoints(A,B)
\tkzLabelPoints[above](C,D)
\tkzDrawPoints[red](I)
\end{tikzpicture}
```

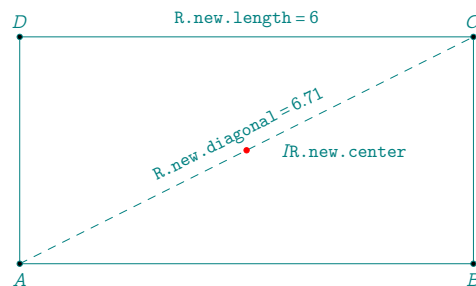

14.2 Rectangle methods

Table 16: Rectangle methods.

Methods	Comments
angle (zi,za,angle)	R.ang = rectangle : angle (z.I,z.A);z.A vertex; ang angle between 2 vertices
gold (za,zb)	R.gold = rectangle : gold (z.A,z.B) length/width = ϕ
diagonal (za,zc)	R.diag = rectangle : diagonal (z.I,z.A) I square center A first vertex
side (za,zb,d)	S.IA = rectangle : side (z.I,z.A) I square center A first vertex
get_lengths ()	S.IA = rectangle : get_lengths () I square center A first vertex

14.2.1 Angle method

```
\begin{tkzelements}
scale = .5
z.A = point : new ( 0 , 0 )
z.B = point : new ( 4 , 0 )
z.I = point : new ( 4 , 3 )
P.ABCD = rectangle : angle ( z.I , z.A , math.pi/6)
z.B = P.ABCD.pb
z.C = P.ABCD.pc
z.D = P.ABCD.pd
\end{tkzelements}
```

```
\begin{tikzpicture}
\tkzGetNodes
\tkzDrawPolygon(A,B,C,D)
\tkzDrawPoints(A,B,C)
\tkzLabelPoints(A,B,C,D)
\tkzDrawPoints[new](I)
\end{tikzpicture}
```

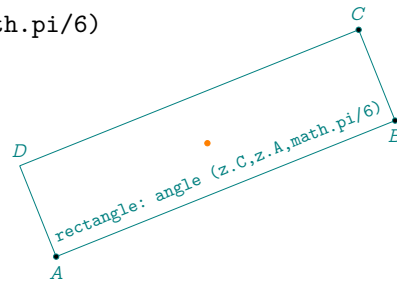

14.2.2 Side method

```
\begin{tkzelements}
z.A = point : new ( 0 , 0 )
z.B = point : new ( 4 , 3 )
R.side = rectangle : side (z.A,z.B,3)
z.C = R.side.pc
z.D = R.side.pd
z.I = R.side.center
\end{tkzelements}
```

```
\begin{tikzpicture}
\tkzGetNodes
\tkzDrawPolygon(A,B,C,D)
\tkzDrawPoints(A,B,C,D)
\tkzLabelPoints(A,B)
\tkzLabelPoints[above](C,D)
\tkzDrawPoints[red](I)
\end{tikzpicture}
```

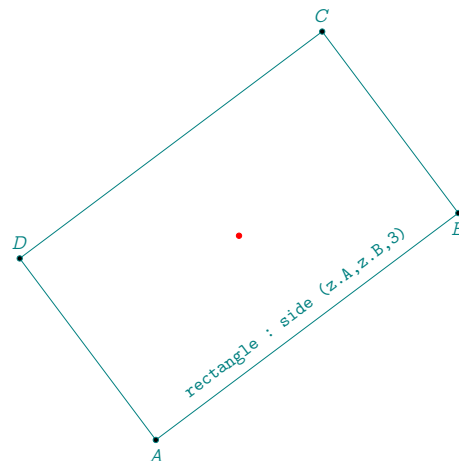

14.2.3 Diagonal method

```

\begin{tkzelements}
z.A      = point : new ( 0 , 0 )
z.C      = point : new ( 4 , 3 )
R.diag   = rectangle : diagonal (z.A,z.C)
z.B      = R.diag.pb
z.D      = R.diag.pd
z.I      = R.diag.center
\end{tkzelements}

\begin{tikzpicture}
\tkzGetNodes
\tkzDrawPolygon(A,B,C,D)
\tkzDrawPoints(A,B,C,D)
\tkzLabelPoints(A,B)
\tkzLabelPoints[above](C,D)
\tkzDrawPoints[red](I)
\tkzLabelSegment[sloped,above](A,B){|rectangle : diagonal (z.A,z.C)|}
\end{tikzpicture}

```

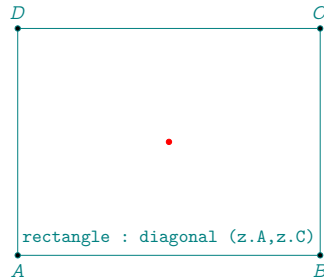

14.2.4 Gold method

```

\begin{tkzelements}
z.X      = point : new ( 0 , 0 )
z.Y      = point : new ( 4 , 2 )
R.gold   = rectangle : gold (z.A,z.B)
z.C      = R.gold.pc
z.D      = R.gold.pd
z.I      = R.gold.center
\end{tkzelements}

\begin{tikzpicture}
\tkzGetNodes
\tkzDrawPolygon(X,Y,Z,W)
\tkzDrawPoints(X,Y,Z,W)
\tkzLabelPoints(X,Y)
\tkzLabelPoints[above](Z,W)
\tkzDrawPoints[red](I)
\tkzLabelSegment[sloped,above](X,Y){|rectangle : gold (z.X,z.Y)|}
\end{tikzpicture}

```

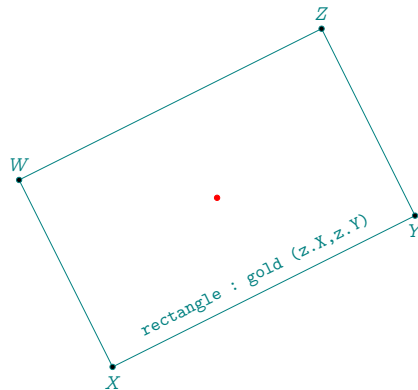

15 Classe parallelogram

15.1 Parallelogram attributes

Points are created in the direct direction. A test is performed to check whether the points form a parallelogram, otherwise compilation is blocked.

```
Creation P.new = parallelogram : new (z.A,z.B,z.C,z.D)
```

Table 17: Parallelogram attributes.

Attributes	Application	
pa	z.A = P.new.pa	
pb	z.B = P.new.pb	
pc	z.C = P.new.pc	
pd	z.D = P.new.pd	
type	P.new.type= 'parallelogram'	
i	z.I = P.new.i	intersection of diagonals
ab	P.new.ab	line passing through two vertices
ac	P.new.ca	idem.
ad	P.new.ad	idem.
bc	P.new.bc	idem.
bd	P.new.bd	idem.
cd	P.new.cd	idem.

15.1.1 Example: attributes

```
\begin{tkzelements}
z.A      = point : new ( 0 , 0 )
z.B      = point : new ( 4 , 1 )
z.C      = point : new ( 7 , 5 )
z.D      = point : new ( 3 , 4 )
P.new    = parallelogram : new (z.A,z.B,z.C,z.D)
z.B      = P.new.pb
z.C      = P.new.pc
z.D      = P.new.pd
z.I      = P.new.i
\end{tkzelements}
\begin{tikzpicture}
\tkzGetNodes
\tkzDrawPolygon(A,B,C,D)
\tkzDrawPoints(A,B,C,D)
\tkzLabelPoints(A,B)
\tkzLabelPoints[above](C,D)
\tkzDrawPoints[red](I)
\end{tikzpicture}
```

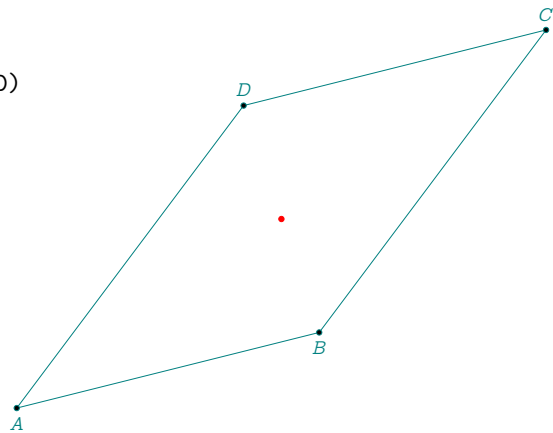

15.2 Parallelogram methods

Table 18: Parallelogram methods.

Methods	Comments
<code>fourth (za,zb,zc)</code>	completes a triangle by parallelogram (see next example)

15.2.1 parallelogram with fourth method

```

\begin{tkzelements}
  scale = .75
  z.A    = point : new ( 0 , 0 )
  z.B    = point : new ( 4 , 1 )
  z.C    = point : new ( 5 , 3 )
  P.four = parallelogram : fourth (z.A,z.B,z.C)
  z.D    = P.four.pd
  z.I    = P.four.center
\end{tkzelements}
\begin{tikzpicture}
\tkzGetNodes
\tkzDrawPolygon(A,D,B,C)
\tkzDrawPoints(A,B,C,D)
\tkzLabelPoints(A,B)
\tkzLabelPoints[above](C,D)
\tkzDrawPoints[red](I)
\end{tikzpicture}

```

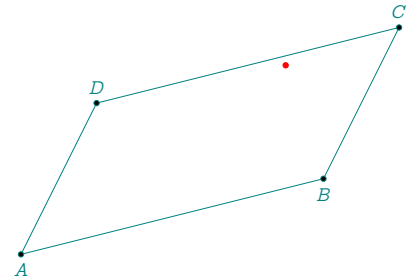

16 Classe Regular Polygon

16.1 regular_polygon attributes

```
Creation RP.IA = regular_polygon : new (z.I,z.A,6)
```

Table 19: Regular_polygon attributes.

Attributes	Application
center	<code>z.I = RP.IA.center</code>
table	array containing all vertex affixes
through	first vertex
circle	defines the circle with center I passing through A
type	<code>RP.IA.type= 'regular_polygon'</code>
side	<code>s = RP.IA.side</code> ; s=length of side
extradius	<code>S.AB.exradius</code> ; radius of the circumscribed circle
inradius	<code>S.AB.inradius</code> ; radius of the inscribed circle
proj	<code>RP.IA.proj</code> ; projection of the center on one side
angle	<code>RP.IA.angle</code> ; angle formed by the center and 2 consecutive vertices

16.1.1 Pentagon

```
\begin{tkzelements}
z.O = point: new (0,0)
z.I = point: new (1,3)
z.A = point: new (2,0)
RP.five = regular_polygon : new (z.I,z.A,5)
RP.five : name ("P_")
C.ins = circle: radius (z.I,RP.five.inradius)
z.H = RP.five.proj
\end{tkzelements}
\begin{tikzpicture}
\def\nb{\tkzUseLua{RP.five.nb}}
\tkzGetNodes
\tkzDrawCircles(I,A I,H)
\tkzDrawPolygon(P_1,P_...,P_\nb)
\tkzDrawPoints[red](P_1,P_...,P_\nb,H,I)
\tkzLabelPoints[red](I,A,H)
\end{tikzpicture}
```

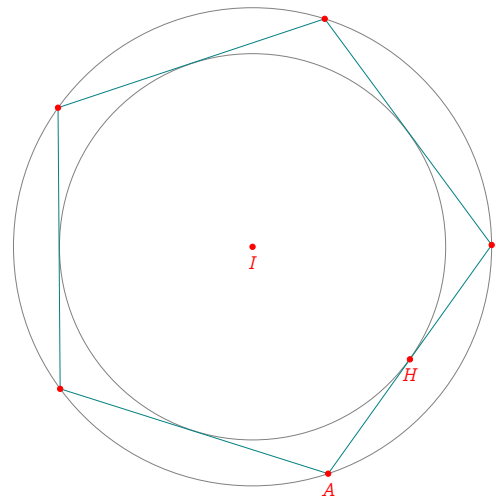

16.2 regular_polygon methods

Table 20: Circle methods.

Methods	Comments
<code>new(O,A,n)</code>	<code>RP.five = regular_polygon : new (z.I,z.A,5)</code> ; I center A first vertex 5 sides
Circle	
<code>incircle ()</code>	<code>C.IH = RP.five : incircle ()</code>
Points	
<code>name (string)</code>	see 16.1.1

17 Math constants and functions

Table 21: Math constants and functions.

contants or functions	Comments
tkzphi	constant $\varphi = (1 + \mathit{math.sqrt}(5))/2$
tkzinvphi	constant $1/\varphi = 1/\mathit{tkzphi}$
tkzsqrtphi	constant $\sqrt{\varphi} = \mathit{math.sqrt}(\mathit{tkzphi})$
islinear (z1,z2,z3)	Are the points aligned? $(z2-z1) \parallel (z3-z1)$?
isortho (z1,z2,z3)	$(z2-z1) \perp (z3-z1)$? boolean
set_lua_to_tex (list)	set_lua_to_tex('a','n') defines \a and \n
tkzUseLua (variable)	<code>\textbackslash\tkzUseLua{a}</code> prints the value of a
value (v)	apply <code>scale * value</code>
real (v)	apply <code>value /scale</code>
angle_normalize (a)	to get a value between 0 and 2π
radical_center (C1,C2,C3)	see 20.29
radical_circle (C1,C2,C3)	see 20.30
barycenter ({z1,n1},{z2,n2}, ...)	barycenter of list of points

17.0.1 Harmonic division with tkzphi

```

\begin{tkzelements}
  scale =.5
  z.a = point: new(0,0)
  z.b = point: new(8,0)
  L.ab = line: new (z.a,z.b)
  z.m,z.n = L.ab: harmonic_both (tkzphi)
\end{tkzelements}
\begin{tikzpicture}
  \tkzGetNodes
  \tkzDrawLine[add= .2 and .2](a,n)
  \tkzDrawPoints(a,b,n,m)
  \tkzLabelPoints(a,b,n,m)
\end{tikzpicture}

```



17.0.2 Function islinear

```

\begin{tkzelements}
  z.a = point: new (1, 1)
  z.b = point: new (2, 2)
  z.c = point: new (4, 4)
  if islinear (z.a,z.b,z.c) then
    z.d = point: new (0, 0)
  else
    z.d = point: new (-1, -1)
  end
\end{tkzelements}
\begin{tikzpicture}
  \tkzGetNodes
  \tkzDrawPoints(a,...,d)
  \tkzLabelPoints(a,...,d)
\end{tikzpicture}

```



17.0.3 Function value

value to apply scaling if necessary

If `scale = 1.2` with `a = value(5)` the actual value of `a` will be $5 \times 1.2 = 6$.

17.0.4 Function real

If `scale = 1.2` with `a = 6` then `real(a) = 6/1.2 = 5`.

17.0.5 Transfer from lua to T_EX

It's possible to transfer variable from Lua to T_EX with `\tkzUseLua`.

```
\begin{tkzelements}
  z.A      = point : new (0 , 0)
  z.B      = point : new (4 , 3)
  z.C      = point : new (2 , 5)
  L.AB     = line  : new (z.A,z.B)
  d        = L.AB : distance (z.C)
  l        = L.AB.length
  z.H      = L.AB : projection (z.C)
\end{tkzelements}
% possible here \tkzUseLua{L.AB.length}
\begin{tikzpicture}
\tkzGetNodes
\tkzDrawLines(A,B C,H)
\tkzDrawPoints(A,B,C,H)
\tkzLabelPoints(A,B,C,H)
\tkzLabelSegment[above left,draw](C,H){$CH = \tkzUseLua{d}$}
\tkzLabelSegment[below left,draw](C,H){$AB = \tkzUseLua{l}$}
\end{tikzpicture}
```

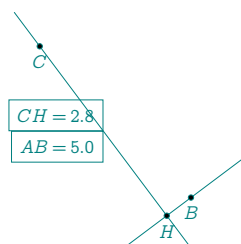

17.0.6 Normalized angles : Slope of lines (ab), (ac) and (ad)

```
\begin{tkzelements}
  z.a      = point: new(0, 0)
  z.b      = point: new(-3, -3)
  z.c      = point: new(0, 3)
  z.d      = point: new(2, -2)
  angle    = point.arg (z.b-z.a)
  tex.print('slope of (ab) : '..tostring(angle)..'\\')
  tex.print('slope normalized of (ab) : '..tostring(angle\_normalize(angle))..'\\')
  angle    = point.arg (z.c-z.a)
  tex.print('slope of (ac) : '..tostring(angle)..'\\')
  tex.print('slope normalized of (ac) : '..tostring(angle\_normalize(angle))..'\\')
  angle    = point.arg (z.d-z.a)
  tex.print('slope of (ad) : '..tostring(angle)..'\\')
  tex.print('slope normalized of (ad) : '..tostring(angle\_normalize(angle))..'\\')
\end{tkzelements}
\begin{tikzpicture}
\tkzGetNodes
\tkzDrawLines[red](a,b a,c a,d)
\tkzDrawPoints(a,b,c,d)
\tkzLabelPoints(a,b,c,d)
\end{tikzpicture}
```

slope of (ab) : -2.3561944901923
 slope normalized of (ab) : 3.9269908169872
 slope of (ac) : 1.5707963267949
 slope normalized of (ac) : 1.5707963267949
 slope of (ad) : -0.78539816339745
 slope normalized of (ad) : 5.4977871437821

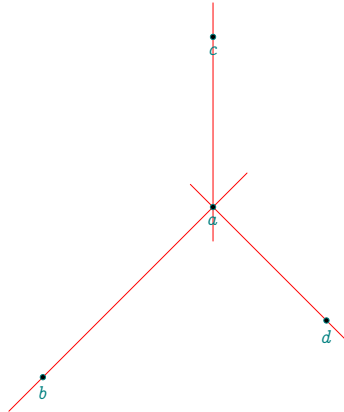

17.0.7 Get angle

The function `get_angle (a,b,c)` gives the angle normalized of (\vec{ab}, \vec{ac}) .

```

\begin{tkzelements}
  z.a = point: new(0, 0)
  z.b = point: new(-2, -2)
  z.c = point: new(0, 3)
  angcb = tkzround ( get_angle (z.a,z.c,z.b),3)
  angbc = tkzround ( get_angle (z.a,z.b,z.c),3)
\end{tkzelements}

\begin{tikzpicture}
  \tkzGetNodes
  \tkzDrawLines[red](a,b a,c)
  \tkzDrawPoints(a,b,c)
  \tkzLabelPoints(a,b,c)
  \tkzMarkAngle[->](c,a,b)
  \tkzLabelAngle(c,a,b){\tkzUseLua{angcb}}
  \tkzMarkAngle[->](b,a,c)
  \tkzLabelAngle(b,a,c){\tkzUseLua{angbc}}
\end{tikzpicture}

```

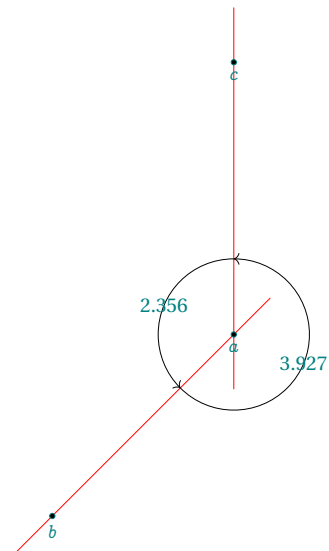

17.0.8 Dot or scalar product

```

\begin{tkzelements}
  z.A    = point: new(0,0)
  z.B    = point: new(5,0)
  z.C    = point: new(0,3)
  T.ABC  = triangle: new (z.A,z.B,z.C)
  z.A_1,
  z.B_1,
  z.C_1  = get_points (T.ABC: anti ())
  x      = dot_product (z.A,z.B,z.C)
\end{tkzelements}
\begin{tikzpicture}
  \tkzGetNodes
  \tkzDrawPolygon(A,B,C)
  \tkzDrawPoints(A,B,C,A_1,B_1,C_1)
  \tkzLabelPoints(A,B,C,A_1,B_1,C_1)
  \tkzDrawPolygon[blue](A_1,B_1,C_1)
  \tkzText[right](0,-
1){dot product =\tkzUseLua{x}}
\end{tikzpicture}

```

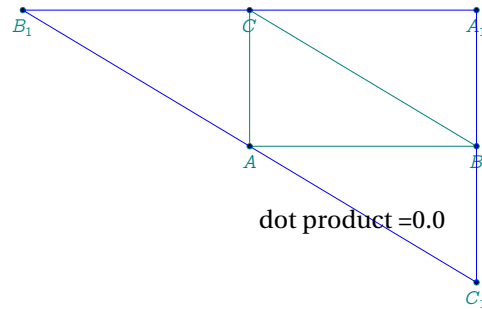

The scalar product of the vectors \overrightarrow{AC} and \overrightarrow{AB} is equal to 0.0, so these vectors are orthogonal.

17.0.9 Alignment or orthogonality

With the functions `islinear` and `isortho`. `islinear(z.a,z.b,z.c)` gives true idf the points a , b and c are aligned.

`isortho(z.a,z.b,z.c)` gives true if the line (ab) is orthogonal to the line (ac) .

17.0.10 Other functions

Not documented because still in beta version: `parabola`, `Cramer22`, `Cramer33`.

18 Intersections

It's an essential tool. For the moment, the classes concerned are lines, circles and ellipses, with the following combinations: line-line; line-circle; circle-circle and line-ellipse. The argument is a pair of objects, in any order. Results consist of one or two values, either points, boolean `false` or underscore `_`.

18.1 Line-line

The result is of the form: point or false.

```
\begin{tkzelements}
  z.A = point : new (1,-1)
  z.B = point : new (4,1)
  z.C = point : new (2,1)
  z.D = point : new (4,-2)
  z.I = point : new (0,0)
  L.AB = line : new (z.A,z.B)
  L.CD = line : new (z.C,z.D)
  x = intersection (L.AB,L.CD)
  if x == false then
    tex.print('error')
  else
    z.I = x
  end
\end{tkzelements}
```

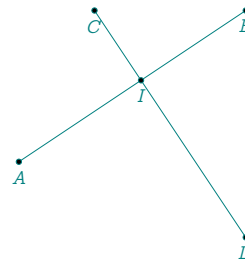

```
\begin{tikzpicture}
  \tkzGetNodes
  \tkzDrawSegments(A,B C,D)
  \tkzDrawPoints(A,B,C,D,I)
  \tkzLabelPoints(A,B,C,D,I)
\end{tikzpicture}
```

Other examples: 9.2.1, 9.2.2, 20.3

18.2 Line-circle

The result is of the form : point , point or false , false. If the line is tangent to the circle, then the two points are identical. You can ignore one of the points by using the underscore: _, point or point , _. When the intersection yields two solutions, the order of the points is determined by the argument of $(z.p - z.c)$ with c center of the circle and p point of intersection. The first solution corresponds to the smallest argument (arguments are between 0 and 2π).

```

\begin{tkzelements}
  z.A = point : new (1,-1)
  z.B = point : new (1,2)
  L.AB = line : new (z.A,z.B)
  z.O = point : new (2,1)
  z.D = point : new (3,1)
  z.E = point : new (3,2)
  L.AE = line : new (z.A,z.E)
  C.OD = circle : new (z.O,z.D)
  z.I,_ = intersection (L.AB,C.OD)
  _,z.K = intersection (C.OD,L.AE)
\end{tkzelements}

\begin{tikzpicture}
\tkzGetNodes
  \tkzDrawLines(A,B A,E)
  \tkzDrawCircle(O,D)
  \tkzDrawPoints(A,B,O,D,I,K)
  \tkzLabelPoints[left] (A,B,O,D,I,K)
\end{tikzpicture}

```

Other examples: 9.2.1

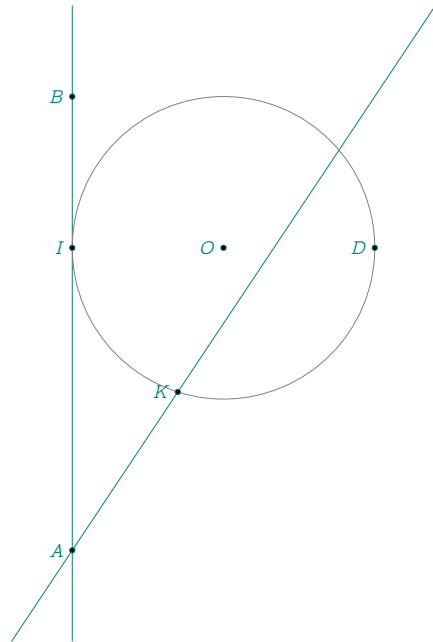

18.3 Circle-circle

The result is of the form : point , point or false , false. If the circles are tangent, then the two points are identical. You can ignore one of the points by using the underscore: `_` , point or point , `_`. As for the intersection of a line and a circle, consider the argument of $z \cdot p - z \cdot c$ with c center of the first circle and p point of intersection. The first solution corresponds to the smallest argument (arguments are between 0 and 2π).

```

\begin{tkzelements}
  z.A      = point : new (1,1)
  z.B      = point : new (2,2)
  z.C      = point : new (3,3)
  z.D      = point : new (3,0)
  C.AB     = circle : new (z.A,z.B)
  C.CB     = circle : new (z.C,z.B)
  z.I,_    = intersection (C.AB,C.CB)
  C.DC     = circle : new (z.D,z.C)
  z.J,z.K  = intersection (C.DC,C.CB)
\end{tkzelements}
\begin{tikzpicture}
  \tkzGetNodes
  \tkzDrawCircles(A,B C,B D,C)
  \tkzDrawPoints(A,I,C,D,J,K)
  \tkzLabelPoints(A,I,C,D,J,K)
\end{tikzpicture}

```

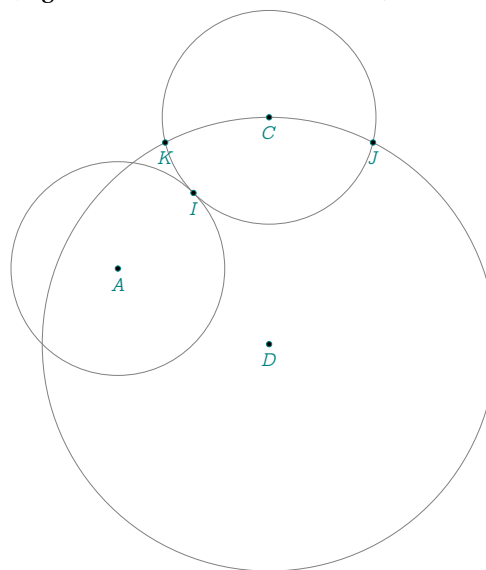

Other examples: 9.2.1, 3.3

18.4 Line-ellipse

The following example is complex, but it shows the possibilities of Lua. The designation of intersection points is a little more complicated than the previous one, as the argument characterizing the major axis must be taken into account. The principle is the same, but this argument must be subtracted. In concrete terms, you need to consider the slopes of the lines formed by the center of the ellipse and the points of intersection, and the slope of the major axis.

```

\begin{tkzelements}
  scale      = .5
  z.a        = point: new (5 , 2)
  z.b        = point: new (-4 , 0)
  z.m        = point: new (2 , 4)
  z.n        = point: new (4 , 4)
  L.ab       = line : new (z.a,z.b)
  L.mn       = line : new (z.m,z.n)
  z.c        = L.ab. mid
  z.e        = L.ab: point (-.2)
  E          = ellipse: foci (z.a,z.b,z.e)
  z.u,z.v    = intersection (E,L.mn)
  -- transfer to tex
  a          = E.Rx
  b          = E.Ry
  ang        = math.deg(E.slope)
\end{tkzelements}
\begin{tikzpicture}
  \tkzGetNodes
  \tkzDrawLines[red](a,b u,v) % p,s p,t
  \tkzDrawPoints(a,b,c,e,u,v) %
  \tkzLabelPoints(a,b,c,u,v)
  \tkzDrawEllipse[teal](c,\tkzUseLua{a},\tkzUseLua{b},\tkzUseLua{ang})
  \tkzDrawSegments(c,u c,v)
  \tkzFillAngles[green!30,opacity=.4](e,c,v)
  \tkzFillAngles[green!80,opacity=.4](e,c,u)
\end{tikzpicture}

```

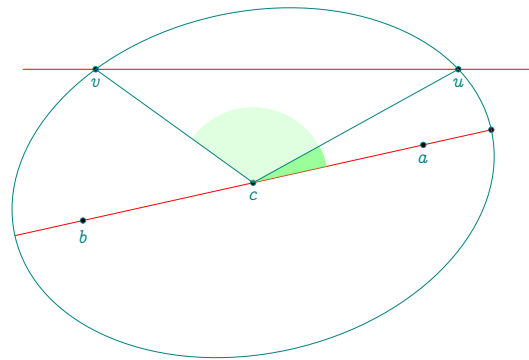

Other examples: 11.2.2, 20.31

19 In-depth study

19.1 The tables

19.1.1 General tables

Tables are the only data structure "container" integrated in Lua. They are associative arrays which associates a key (reference or index) with a value in the form of a field (set) of key/value pairs. Moreover, tables have no fixed size and can grow based on our need dynamically.

Tables are created using table constructors, the simplest of which is the use of braces, e.g. `{}`. This defines an empty table.

```
F = {"banana", "apple", "cherry"}
```

`print(F[2])` -> pomme

qui peut être également défini par

```
FR = {[1] = "banana", [3] = "cherry", [2] = "apple"}
```

`print(FR[3])` -> cherry

`FR[4] = "orange"`

```
print(#FR)
-- I for Index
for I,V in ipairs(FR) do
    print(I,V)
end
```

1 banana

2 apple

3 cherry

4 orange

```
C = {"banana" = "yellow" , ["apple"] = "green" , ["cherry"] = "red" }
C.orange = "orange"
```

```
for K,V in pairs (C) do
    print(K,V)
end
```

banana = yellow cherry = red orange = orange apple = green

Another useful feature is the ability to create a table to store an unknown number of function parameters, for example:

```
function ReturnTable (...)
    return table.pack (...)
end
```

```
function ParamToTable (...)
  mytab = ReturnTable(...)
  for i=1,mytab.n do
    print(mytab[i])
  end
end
ParamToTable("cherry","apple","orange")
```

Using tables with table[key] syntax:

C["banana"] and F[1]

But with string constants as keys we have the sugar syntax: C.banana but this syntax does not accept numbers. It's possible to erase a key/value pair from a table, with :

```
C.banana = nil
```

19.1.2 Table z

This is the most important table in the package. It stores all points and enables them to be transferred to TikZ. It is defined with `z = {}`, then each time we write

```
z.name = point : new (a , b)
```

a point object is stored in the table. The key is name, the value is an object. We have seen that `z.name.re = a` and that `z.name.im = b`.

However, the elements of this table have essential properties.

For example, if you wish to display an element, then `tex.print(tostring(z.name)) = a+ib` the `tostring` operation displays the affix corresponding to the point.

In addition, we'll see that it's possible to perform operations with the elements of the z table.

19.2 Transferts

We've seen (sous-section 5.1.1) that the macro transfers point coordinates to TikZ. Let's take a closer look at this macro:

```
\def\tkzGetNodes{\directlua{%
  for K,V in pairs(z) do
    local K,n,sd,ft
    n = string.len(KS)
    if n > 1 then
      _,_,ft, sd = string.find( K , "(.+)(") )
      if sd == "p" then K=ft.."'" end
    end
    tex.print("\coordinate ("..K..) at ("..V.re..","..V.im..) ;\\")
  end}
}
```

It consists mainly of a loop. The variables used are K (for keys) and V (for Values). To take pairs (key/value) from the z table, use the pairs function. K becomes the name of a node whose coordinates are V.re and V.im. Meanwhile, we search for keys with more than one symbol ending in p, in order to associate them with the symbol "" valid in TikZ.

19.3 Complex numbers library and point

Unless you want to create your own functions, you won't need to know and use complex numbers. However, in some cases it may be useful to implement some of their properties.

`z.A = point : new (1,2)` and `z.B = point : new (1,-1)` define two affixes which are $z_A = 1 + 2i$ and $z_B = 1 - i$. Note the difference in notations `z.A` and z_A for two distinct entities: a Lua object and an affix.

If you want to use only complex numbers then you must choose the following syntax `za =point (1,2)`. The difference between `z.A = point : new (1,2)` and `za = point (1,2)` is that the first function takes into account the scale. If `scale = 2` then $z_A = 2 + 4i$. In addition, the object referenced by A is stored in table z and not za.

The notation may come as a surprise, as I used the term "point". The aim here was not to create a complete library on complex numbers, but to be able to use their main properties in relation to points. I didn't want to have two different levels, and since a unique connection can be established between the points of the plane and the complexes, I decided not to mention the complex numbers! But they are there.

Table 22: Point or complex metamethods.

Metamethods	Application	
<code>__add(z1,z2)</code>	<code>z.a + z.b</code>	affix
<code>__sub(z1,z2)</code>	<code>z.a - z.b</code>	affix
<code>__unm(z)</code>	<code>- z.a</code>	affix
<code>__mul(z1,z2)</code>	<code>z.a * z.b</code>	affix
<code>__concat(z1,z2)</code>	<code>z.a .. z.b</code>	dot product = real number ^a
<code>__pow(z1,z2)</code>	<code>z.a ^ z.b</code>	determinant = real number
<code>__div(z1,z2)</code>	<code>z.a / z.b</code>	affix
<code>__tostring(z)</code>	<code>tex.print(tostring(z))</code>	displays the affix
<code>__tonumber(z)</code>	<code>tonumber(z)</code>	affix or nil
<code>__eq(z1,z2)</code>	<code>eq (z.a,z.b)</code>	boolean

^a If O is the origin of the complex plan, then we get the dot product of the vectors \vec{Oa} and \vec{Ob}

Table 23: Point (complex) class methods.

Methods	Application	
<code>conj(z)</code>	<code>z.a : conj()</code>	affix (conjugate)
<code>mod(z)</code>	<code>z.a : mod()</code>	real number = modulus <code>z.a</code>
<code>abs(z)</code>	<code>z.a : abs()</code>	real number = modulus
<code>norm(z)</code>	<code>z.a : norm()</code>	norm (real number)
<code>arg(z)</code>	<code>z.a : arg()</code>	real number = argument of <code>z.a</code> (in rad)
<code>get(z)</code>	<code>z.a : get()</code>	re and im (two real numbers)
<code>sqrt(z)</code>	<code>z.a : sqrt()</code>	affix

The class is provided with two specific metamethods.

- Since concatenation makes little sense here, the operation associated with `..` is the scalar or dot product.
If $z1 = a+ib$ and $z2 = c+id$ then
 $z1..z2 = (a+ib) .. (c+id) = (a+ib) (c-id) = ac+bd + i(bc-ad)$
There's also a mathematical function, `dot_product`, which takes three arguments. See example 17.0.8
- With the same idea, the operation associated with `^` is the determinant i.e.
 $z1 ^ z2 = (a+ib) ^ (c+id) = ad - bc$ From $(a-ib) (c+id) = ac+bd + i(ad - bc)$ we take the imaginary part.

19.3.1 Example of complex use

Let `za = math.cos(a) + i math.sin(a)`. This is obtained from the library by writing

```
za = point(math.cos(a),math.sin(a)).
```

Then $z.B = z.A * za$ describes a rotation of point A by an angle a.

```
\begin{tkzelements}
  z.O = point : new (0,0)
  z.A = point : new (1,2)
  a = math.pi/6
  za = point(math.cos(a),math.sin(a))
  z.B = z.A * za
\end{tkzelements}
\begin{tikzpicture}
\tkzGetNodes
\tkzDrawPoints(O,A,B)
\tkzDrawArc[->,delta=0] (O,A) (B)
\tkzDrawSegments[dashed] (O,A O,B)
\tkzLabelAngle(A,O,B){$\pi/6$}
\end{tikzpicture}
```

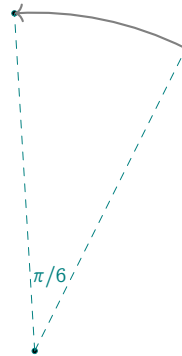

19.3.2 Point operations(complex)

```
\begin{tkzelements}
  z.o = point: new(0,0)
  z.a = point: new(1,-1)
  z.b = point: new(2,1)
  z.bp = -z.b
  z.c = z.a + z.b
  z.d = z.a - z.b
  z.e = z.a * z.b
  z.f = z.a / z.b
  z.ap = point.conj (z.a)
  -- = z.a : conj ()
  z.g = z.b* point(math.cos(math.pi/2),
    math.sin(math.pi/2))
\end{tkzelements}
```

```
\hspace*{\fill}
\begin{tikzpicture}
\tkzGetNodes
\tkzInit[xmin=-2,xmax=3,ymin=-2,ymax=3]
\tkzGrid
\tkzDrawSegments(o,a o,b o,c o,e o,b' o,f o,g)
\tkzDrawSegments[red] (a,c b,c b',d a,d)
\tkzDrawPoints(a,...,g,o,a',b')
\tkzLabelPoints(o,a,b,c,d,e,f,g,a',b')
\end{tikzpicture}
```

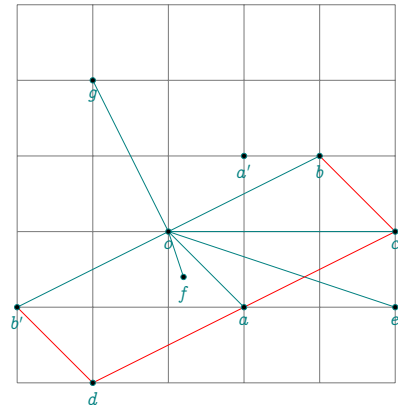

19.4 Barycenter

Here's the definition of the barycenter, which is used some forty times in the package.

`table.pack` builds a table from a list.

`tp.n` gives the number of pairs.

`tp[i][1]` is an affix and `tp[i][2]` the associated weight (real value). See the example.

```
function barycenter_ (...)
  local tp = table.pack(...)
  local i
  local sum = 0
  local weight=0
  for i=1,tp.n do
    sum = sum + tp[i][1]*tp[i][2]
    weight = weight + tp[i][2]
  end
  return sum/weight
end
```

19.4.1 Using the barycentre

```
\begin{tkzelements}
z.A = point: new (1,0)
z.B = point: new (5,-1)
z.C = point: new (2,5)
z.G = barycenter ({z.A,3},{z.B,1},{z.C,1})
\end{tkzelements}
```

```
\begin{tikzpicture}
\tkzGetNodes
\tkzDrawPolygon(A,B,C)
\tkzDrawPoints(A,B,C,G)
\end{tikzpicture}
```

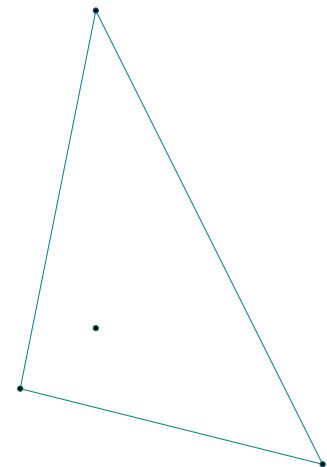

19.4.2 Incenter of a triangle

The calculation of the weights k_a , k_b and k_c is precise, and the result obtained with the barycenter is excellent. Note the presence of the underscore `_` for certain functions. These functions are internal (developer). Each external (user) function is associated with its internal counterpart.

Here's how to determine the center of the inscribed circle of a triangle:

```
function in_center_ ( a,b,c )
  local ka = point.abs (b-c)
  local kc = point.abs (b-a)
  local kb = point.abs (c-a)
  return barycenter_ ( {a,ka} , {b,kb} , {c,kc} )
end
```

19.5 Loop and table notation

The problem encountered in this example stems from the notation of the point names. Since it's not possible to write in simplified form, we have to resort to `table[key]` notation.

```

\begin{tkzelements}
  local r = 3
  z.0 = point : new (0,0)
  max = 100
  for i = 1,max
  do
    z["A_"..i] = point : polar(r,2*i*math.pi/max)
  end
  a = math.deg(get_angle (z.0,z.A_1,z.A_2))
\end{tkzelements}

```

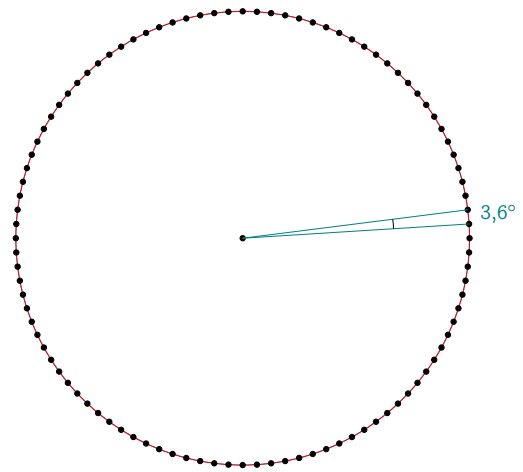

19.6 In_out method

This function can be used for the following objects

- line
- circle
- triangle
- ellipse

The disk object doesn't exist, so with `in_out_disk` it's possible to determine whether a point is in a disk.

19.6.1 In_out for a line

```

function line: in_out (pt)
  local sc,epsilon
  epsilon = 10^(-12)
  sc = math.abs ((pt-self.pa)^(pt-self.pb))
  if sc <= epsilon
  then
    return true
  else
    return false
  end
end

```

The `ifthen` package is required for the code below.

```

\begin{tkzelements}
z.A = point: new (0,0)
z.B = point: new (1,2)
z.X = point: new (2,4.000)
z.Y = point: new (2,4.1)
L.AB = line : new (z.A,z.B)
if L.AB : in_out (z.X)
  then
    inline = true k = (z.X-z.A)/(z.B-z.A)
  else
    inline = false
  end
  inline_bis = L.AB : in_out (z.Y)
\end{tkzelements}

```

```

\begin{tikzpicture}
\tkzGetNodes
\tkzDrawPoints(A,B,X,Y)
\tkzLabelPoints(A,B,X)
\tkzLabelPoints[left](Y)
\ifthenelse{\equal{\tkzUseLua{inline}}{true}}{
  \tkzDrawSegment[red](A,B)
  \tkzLabelSegment(A,B){AX/AB = $\tkzUseLua{k}$}{%
  \tkzDrawSegment[blue](A,B)}
\ifthenelse{\equal{\tkzUseLua{inline_bis}}{false}}{
  \tkzDrawSegment[green](B,Y)}{}
\end{tikzpicture}

```

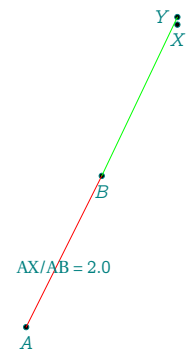

19.7 Determinant and dot product

19.7.1 Determinant

We've just seen how to use \wedge to obtain the determinant associated with two vectors.

`in_out` is simply a copy of `islinear`.

Here's the definition and transformation of the power of a complex number.

```

-- determinant is '^' ad - bc
function point.__pow(z1,z2)
  local z
  z = point.conj(z1) * z2 -- (a-ib) (c+id) = ac+bd + i(ad - bc)
  return z.im
end

```

19.7.2 Dot product

Here's the definition of the dot product between two affixes and the concatenation transformation.

```

-- dot product is '..' result ac + bd
function point.__concat(z1,z2)
  local z
  z = z1 * point.conj(z2) -- (a+ib) (c-id) = ac+bd + i(bc-ad)
  return z.re
end

```

19.7.3 Dot product: orthogonality test

Here's a function `isortho` to test orthogonality between two vectors.

```
function isortho (z1,z2,z3)
  local epsilon
  local dp
  epsilon = 10(-8)
  dp = (z2-z1) .. (z3-z1)
  if math.abs(dp) < epsilon
    then
      return true
    else
      return false
    end
  end
end
```

19.7.4 Dot product: projection

The projection of a point onto a straight line is a fundamental function, and its definition is as follows:

```
function projection_ ( pa,pb,pt )
  local v
  local z
  if aligned ( pa,pb,pt ) then
    return pt
  else
    v = pb - pa
    z = ((pt - pa)..v)/(point.norm(v)) -- .. dot product
    return pa + z * v
  end
end
```

The function `aligned` is equivalent to `islinear` but does not use a determinant. It will be replaced in a future version.

19.8 Point method

The point method is a method for many objects:

- line ,
- circle,
- ellipse,
- triangle.

You obtain a point on the object by entering a real number between 0 and 1.

```

\begin{tkzelements}
  z.A = point : new ( 0 , 0 )
  z.B = point : new ( 4 , 2 )
  z.C = point : new ( 1 , 3 )
  L.AB = line : new (z.A,z.B)
  C.AB = circle : new (z.A,z.B)
  T.ABC = triangle : new (z.A,z.B,z.C)
  z.I = L.AB : point (0.5)
  z.J = C.AB : point (0.5)
  z.K = T.ABC : point (0.5)
\end{tkzelements}
\begin{tikzpicture}
  \tkzGetNodes
  \tkzDrawline(A,B)
  \tkzDrawCircle(A,B)
  \tkzDrawPolygon(A,B,C)
  \tkzDrawPoints(A,B,C,I,J,K)
\end{tikzpicture}

```

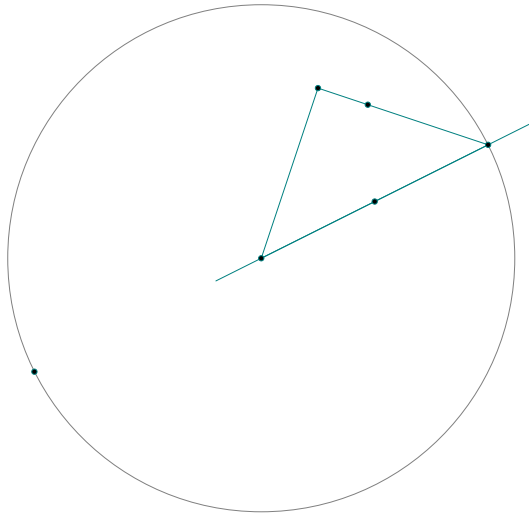

20 Examples

20.1 D'Alembert 1

```

\begin{tkzelements}
  z.A = point : new (0,0)
  z.a = point : new (4,0)
  z.B = point : new (7,-1)
  z.b = point : new (5.5,-1)
  z.C = point : new (5,-4)
  z.c = point : new (4.25,-4)
  C.Aa = circle : new (z.A,z.a)
  C.Bb = circle : new (z.B,z.b)
  C.Cc = circle : new (z.C,z.c)
  z.I = C.Aa : external_similitude (C.Bb)
  z.J = C.Aa : external_similitude (C.Cc)
  z.K = C.Cc : external_similitude (C.Bb)
  z.Ip = C.Aa : internal_similitude (C.Bb)
  z.Jp = C.Aa : internal_similitude (C.Cc)
  z.Kp = C.Cc : internal_similitude (C.Bb)
\end{tkzelements}
\begin{tikzpicture}[rotate=-60]
  \tkzGetNodes
  \tkzDrawCircles(A,a B,b C,c)
  \tkzDrawPoints(A,B,C,I,J,K,I',J',K')
  \tkzDrawSegments[new](I,K A,I A,J B,I B,K C,J C,K)
  \tkzDrawSegments[purple](I,J' I',J I',K)
  \tkzLabelPoints(I,J,K,I',J',K')
\end{tikzpicture}

```

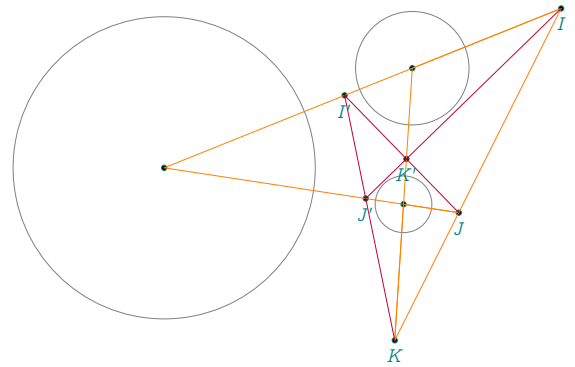

20.2 D'Alembert 2

```

\begin{tkzelements}
  scale = .75
  z.A = point : new (0,0)
  z.a = point : new (5,0)
  z.B = point : new (7,-1)
  z.b = point : new (3,-1)
  z.C = point : new (5,-4)
  z.c = point : new (2,-4)
  C.Aa = circle : new (z.A,z.a)
  C.Bb = circle : new (z.B,z.b)
  C.Cc = circle : new (z.C,z.c)
  z.i,z.j = get_points (C.Aa : radical_axis (C.Bb))
  z.k,z.l = get_points (C.Aa : radical_axis (C.Cc))
  z.m,z.n = get_points (C.Bb : radical_axis (C.Cc))
\end{tkzelements}
\begin{tikzpicture}
  \tkzGetNodes
  \tkzDrawCircles(A,a B,b C,c)
  \tkzDrawLines[new](i,j k,l m,n)
\end{tikzpicture}

```

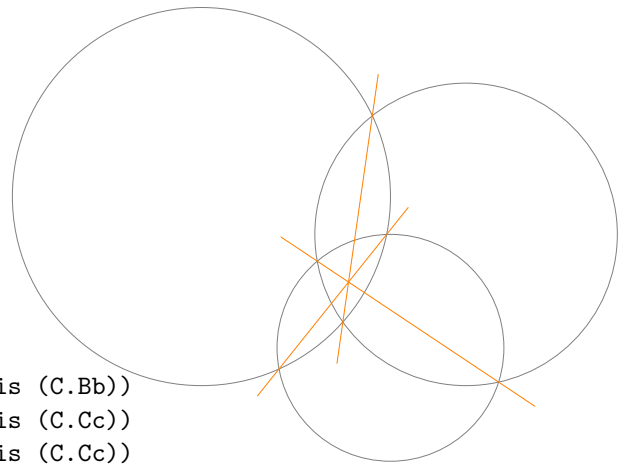

20.3 Alternate

```

\begin{tkzelements}
z.A = point: new (0 , 0)
z.B = point: new (6 , 0)
z.C = point: new (1 , 5)
T = triangle: new (z.A,z.B,z.C)
z.I = T.incenter
L.AI = line: new (z.A,z.I)
z.D = intersection (L.AI,T.bc)
L.LLC = T.ab: ll_from (z.C)
z.E = intersection (L.AI,L.LLC)
\end{tkzelements}
\begin{tikzpicture}
\tkzGetNodes
\tkzDrawPolygon(A,B,C)
\tkzDrawLine[purple](C,E)
\tkzDrawSegment[purple](A,E)
\tkzFillAngles[purple!30,opacity=.4](B,A,C C,E,D)
\tkzMarkAngles[mark=|](B,A,D D,A,C C,E,D)
\tkzDrawPoints(A,...,E)
\tkzLabelPoints(A,B)
\tkzLabelPoints[above](C,D,E)
\tkzMarkSegments(A,C C,E)
\end{tikzpicture}

```

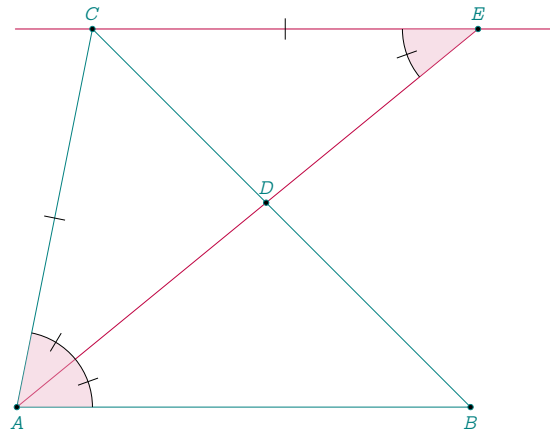

20.4 Apollonius circle

```

\begin{tkzelements}
scale=.75
z.A = point: new (0 , 0)
z.B = point: new (6 , 0)
z.M = point: new (5 , 3)
T.MAB = triangle : new (z.M,z.A,z.B)
L.bis = T.MAB : bisector ()
z.C = L.bis.pb
L.bisext = T.MAB : bisector_ext ()
z.D = intersection (T.MAB.bc, L.bisext)
L.CD = line: new (z.C,z.D)
z.O = L.CD.mid
L.AM = T.MAB.ab
z.E = z.M : symmetry (z.A)
\end{tkzelements}
\begin{tikzpicture}
\tkzGetNodes
\tkzDrawSegment[add=0 and 1](A,M)
\tkzDrawSegments[purple](M,C M,D)
\tkzDrawCircle[purple](O,C)
\tkzDrawSegments(A,B B,M D,B)
\tkzDrawPoints(A,B,M,C,D)
\tkzLabelPoints[below right](A,B,C,D)
\tkzLabelPoints[above](M)
\tkzFillAngles[opacity=.4,cyan!20](A,M,B)
\tkzFillAngles[opacity=.4,purple!20](B,M,E)
\end{tikzpicture}

```



```

\tkzLabelPoints[above](M)
\tkzMarkRightAngle[opacity=.4,fill=gray!20](C,M,D)
\end{tikzpicture}

```

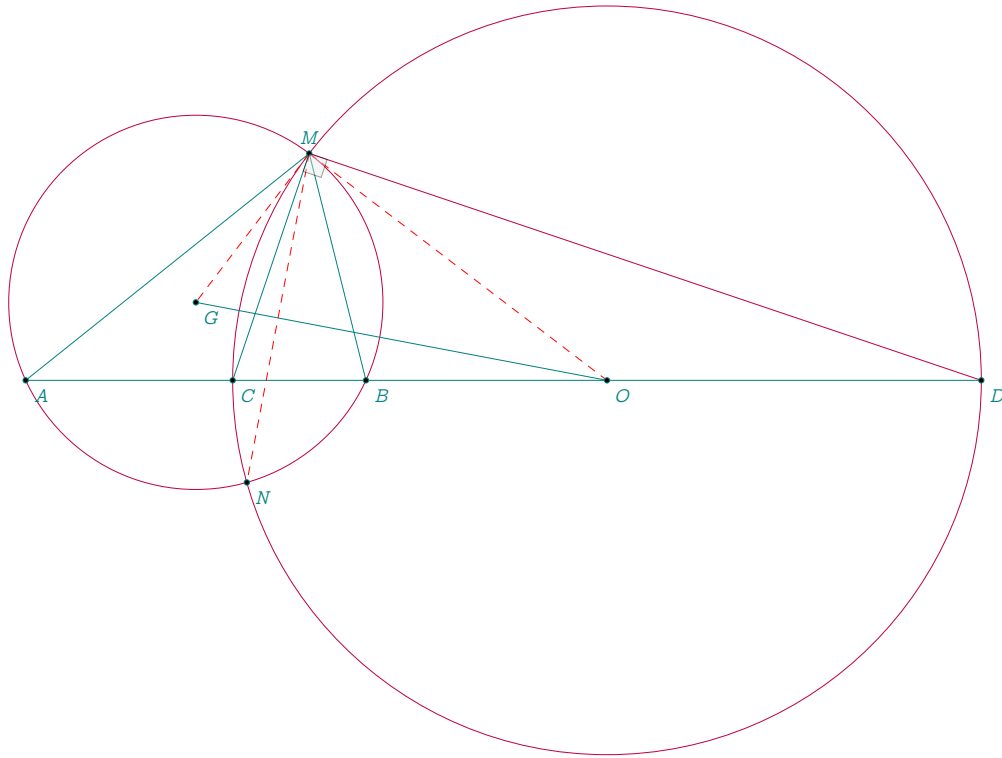

20.6 Apollonius circles in a triangle

```

\begin{tkzelements}
z.A = point: new (0 , 0)
z.B = point: new (6 , 0)
z.C = point: new (4.5 , 1)
T.ABC = triangle: new (z.A,z.B,z.C)
z.I = T.ABC.incenter
z.O = T.ABC.circumcenter
L.CI = line: new (z.C,z.I)
z.Cp = intersection (T.ABC.ab , L.CI)
z.x = L.CI.north_pa
L.Cx = line: new (z.C,z.x)
z.R = intersection (L.Cx,T.ABC.ab)
L.CpR = line: new (z.Cp,z.R)
z.O1 = L.CpR.mid
L.AI = line: new (z.A,z.I)
z.Ap = intersection (T.ABC.bc , L.AI)
z.y = L.AI.north_pa
L.Ay = line: new (z.A,z.y)
z.S = intersection (L.Ay,T.ABC.bc)
L.ApS = line: new (z.Ap,z.S)
z.O2 = L.ApS.mid
L.BI = line: new (z.B,z.I)
z.Bp = intersection (T.ABC.ca , L.BI)
z.z = L.BI.north_pa

```

```

L.Bz = line: new (z.B,z.z)
z.T = intersection (L.Bz,T.ABC.ca)
L.Bpt = line: new (z.Bp,z.T)
z.O3 = L.Bpt.mid
\end{tkzelements}
\begin{tikzpicture}
\tkzGetNodes
\tkzDrawCircles[blue!50!black](O1,C' O2,A' O3,B')
\tkzDrawSegments[new](B,S C,T A,R)
\tkzDrawPolygon(A,B,C)
\tkzDrawPoints(A,B,C,A',B',C',O,I,R,S,T,O1,O2,O3)
\tkzLabelPoints(A,B,C,A',B',C',O,I)
\tkzLabelPoints(O1,O2,O3)
\tkzDrawCircle[purple](O,A)
\tkzDrawLine(O1,O2)
\end{tikzpicture}

```

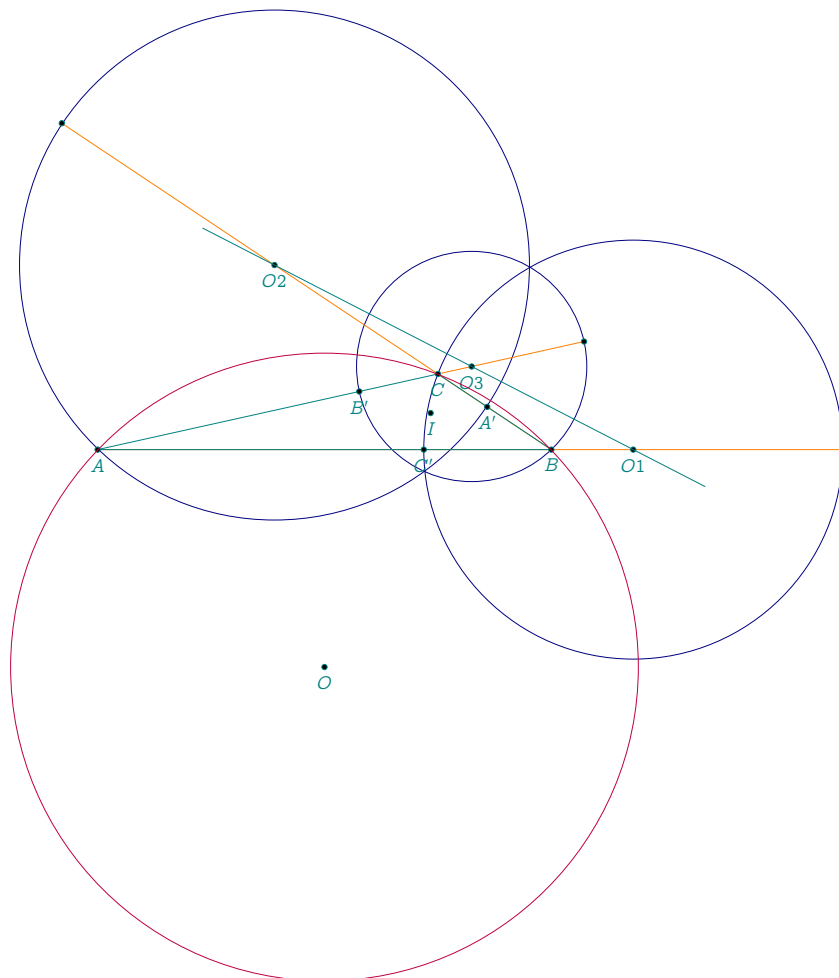

20.7 Archimedes

```

\begin{tkzelements}
  z.O_1 = point: new (0, 0)
  z.O_2 = point: new (0, 1)
  z.A = point: new (0, 3)
  z.F = point: polar (3, math.pi/6)
  L = line: new (z.F,z.O_1)
  C = circle: new (z.O_1,z.A)
  z.E = intersection (L,C)
  T = triangle: new (z.F,z.E,z.O_2)
  z.x = T: parallelogram ()
  L = line: new (z.x,z.O_2)
  C = circle: new (z.O_2,z.A)
  z.C,z.D = intersection (L ,C)
\end{tkzelements}
\begin{tikzpicture}
  \tkzGetNodes
  \tkzDrawCircles(O_1,A O_2,A)
  \tkzDrawSegments[new](O_1,A E,F C,D)
  \tkzDrawSegments[purple](A,E A,F)
  \tkzDrawPoints(A,O_1,O_2,E,F,C,D)
  \tkzLabelPoints(A,O_1,O_2,E,F,C,D)
\end{tikzpicture}

```

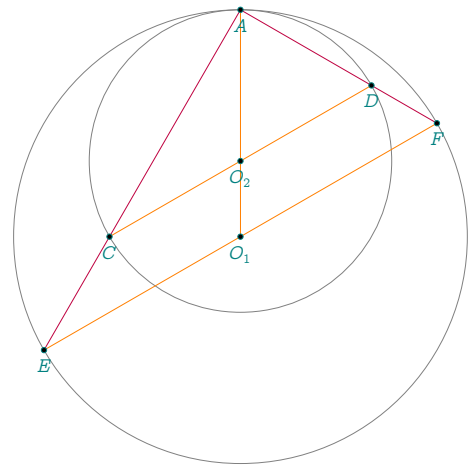

```

\begin{tkzelements}
  z.A = point: new (0 , 0)
  z.B = point: new (10 , 0)
  L.AB = line : new (z.A,z.B)
  z.C = L.AB: gold_ratio ()
  L.AC = line : new (z.A,z.C)
  L.CB = line : new (z.C,z.B)
  z.O_0 = L.AB.mid
  z.O_1 = L.AC.mid
  z.O_2 = L.CB.mid
  C.O0B = circle : new (z.O_0,z.B)
  C.O1C = circle : new (z.O_1,z.C)
  C.O2C = circle : new (z.O_2,z.B)
  z.Pp = C.O0B : midarc (z.B,z.A)
  z.P = C.O1C : midarc (z.C,z.A)
  z.Q = C.O2C : midarc (z.B,z.C)
  L.O1O2 = line : new (z.O_1,z.O_2)
  L.O0O1 = line : new (z.O_0,z.O_1)
  L.O0O2 = line : new (z.O_0,z.O_2)
  z.M_0 = L.O1O2 : harmonic_ext (z.C)
  z.M_1 = L.O0O1 : harmonic_int (z.A)
  z.M_2 = L.O0O2 : harmonic_int (z.B)
  L.BP = line : new (z.B,z.P)
  L.AQ = line : new (z.A,z.Q)
  z.S = intersection (L.BP,L.AQ)
  L.PpO0 = line : new (z.Pp,z.O_0)
  L.PC = line : new (z.P,z.C)
  z.Ap = intersection (L.PpO0,L.PC)

```



```

L.CS      = line : new (z.C,z.S)
C.M1A     = circle : new (z.M_1,z.A)
C.M2B     = circle : new (z.M_2,z.B)
z.P_0     = intersection (L.CS,C.O0B)
z.P_1     = intersection (C.M2B,C.O1C)
z.P_2     = intersection (C.M1A,C.O2C)
T.P0P1P2  = triangle : new (z.P_0,z.P_1,z.P_2)
z.O_4     = T.P0P1P2.circumcenter
T.CP1P2   = triangle : new (z.C,z.P_1,z.P_2)
z.O_5     = T.CP1P2.circumcenter
\end{tkzelements}
\begin{tikzpicture}
\tkzGetNodes
\tkzDrawSemiCircles[teal](O_0,B)
\tkzDrawSemiCircles[teal,fill=teal!20,opacity=.5](O_1,C O_2,B)
\tkzDrawCircle[fill=green!10](O_4,P_0)
\tkzDrawCircle[purple,fill=purple!10,opacity=.5](O_5,C)
\tkzDrawSegments(A,B O_0,P' B,P A,Q)
\tkzDrawSegments(P,B Q,O_2 P,O_1)
\tkzDrawSegments[purple](O_5,P_2 O_5,P_1 O_5,C)
\tkzDrawPoints(A,B,C,P_0,P_2,P_1,O_0,O_1,O_2,O_4,O_5,Q,P,P',S)
\tkzLabelPoints[below](A,B,C,O_0,O_1,O_2,P')
\tkzLabelPoints[above](Q,P)
\tkzLabelPoints[above right](P_0,P_2,P_1,O_5,O_4,S)
\begin{scope}[font=\scriptsize]
\tkzLabelCircle[above](O_1,C)(120){\beta}
\tkzLabelCircle[above](O_2,B)(70){\gamma}
\tkzLabelCircle[above](O_0,B)(110){\alpha}
\tkzLabelCircle[left](O_4,P_2)(60){\delta}
\tkzLabelCircle[left](O_5,C)(140){\epsilon}
\end{scope}
\end{tikzpicture}

```

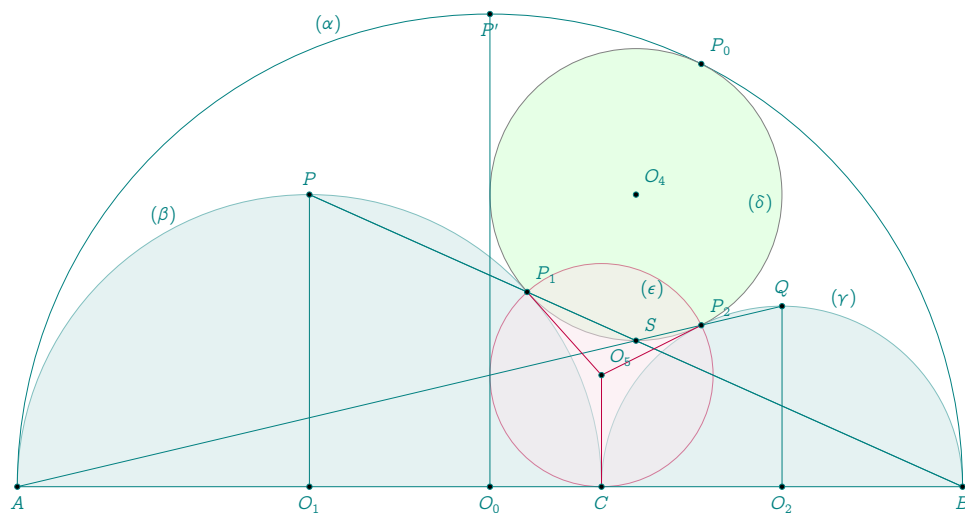

20.8 Excircles

```

\begin{tkzelements}
scale      = 0.7
z.A        = point: new (0,0)

```

```

z.B           = point: new (6,0)
z.C           = point: new (.8,4)
T             = triangle: new ( z.A, z.B, z.C)
z.K           = T.centroid
z.J_a,z.J_b,z.J_c = get_points (T: excentral())
z.T_a,z.T_b,z.T_c = get_points (T: extouch())
la            = line: new ( z.A, z.T_a)
lb            = line: new ( z.B, z.T_b)
z.G           = intersection (la,lb)
\end{tkzelements}
\begin{tikzpicture}
  \tkzGetNodes
  \tkzDrawPoints[new] (J_a,J_b,J_c)
  \tkzClipBB
  \tkzDrawCircles[gray] (J_a,T_a J_b,T_b J_c,T_c)
  \tkzDrawLines[add=1 and 1] (A,B B,C C,A)
  \tkzDrawSegments[new] (A,T_a B,T_b C,T_c)
  \tkzDrawSegments[new] (J_a,T_a J_b,T_b J_c,T_c)
  \tkzDrawPolygon(A,B,C)
  \tkzDrawPolygon[new] (T_a,T_b,T_c)
  \tkzDrawPoints(A,B,C,K)
  \tkzDrawPoints[new] (T_a,T_b,T_c)
  \tkzLabelPoints[below left] (A)
  \tkzLabelPoints[below] (B)
  \tkzLabelPoints[above] (C)
  \tkzLabelPoints[new,below left] (T_b)
  \tkzLabelPoints[new,below right] (T_c)
  \tkzLabelPoints[new,right=6pt] (T_a)
  \tkzMarkRightAngles[fill=gray!15] (J_a,T_a,B J_b,T_b,C J_c,T_c,A)
\end{tikzpicture}

```

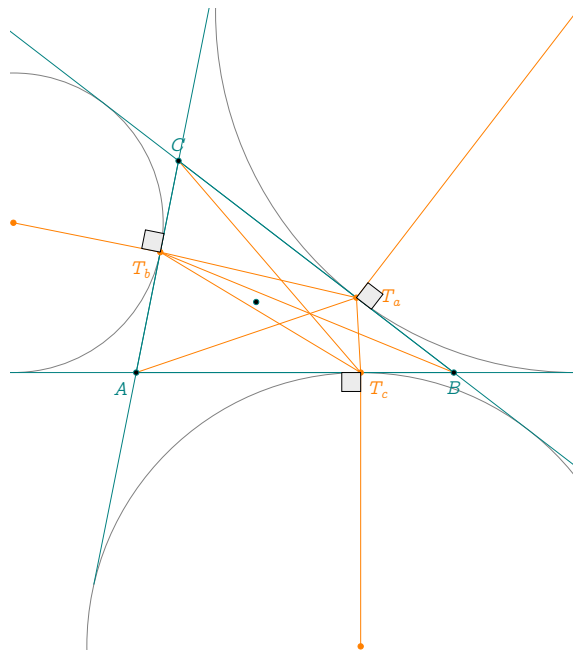

20.9 Orthogonal circle through

```

\begin{tkzelements}
  z.O = point: new (0,1)
  z.A = point: new (1,0)
  z.z1 = point: new (-1.5,-1.5)
  z.z2 = point: new (2.5,-1.25)
  C.OA = circle: new (z.O,z.A)
  C = C.OA: orthogonal_through (z.z1,z.z2)
  z.c = C.center
\end{tkzelements}
\begin{tikzpicture}
  \tkzGetNodes
  \tkzDrawCircle(O,A)
  \tkzDrawCircle[new](c,z1)
  \tkzDrawPoints[new](O,A,z1,z2,c)
  \tkzLabelPoints[right](O,A,z1,z2,c)
\end{tikzpicture}

```

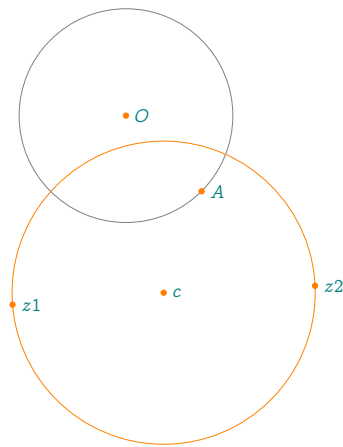

20.10 Devine ratio

```

\begin{tkzelements}
z.A = point: new (0 , 0)
z.B = point: new (8 , 0)
L.AB = line: new (z.A,z.B)
z.C = L.AB: gold_ratio ()
L.AC = line: new (z.A,z.C)
z.O_1 = L.AC.mid
_,_,z.G,z.H = get_points(L.AB: square ())
_,_,z.E,z.F = get_points(L.AC: square ())
L.CB = line: new (z.C,z.B)
z.O_2 = L.CB.mid
z.O_0 = L.AB.mid
L.BE = line: new (z.B,z.E)
L.GH = line: new (z.G,z.H)
z.K = intersection (L.BE,L.GH)
C0 = circle: new (z.O_0,z.B)
z.R,_ = intersection (L.BE,C0)
C2 = circle: new (z.O_2,z.B)
z.S,_ = intersection (L.BE,C2)
L.AR = line: new (z.A,z.R)
C1 = circle: new (z.O_1,z.C)

```

```

_,z.T      = intersection (L.AR,C1)
L.BG      = line: new (z.B,z.G)
z.L       = intersection (L.AR,L.BG)
\end{tkzelements}
\begin{tikzpicture}
\tkzGetNodes
\tkzDrawPolygons(A,C,E,F A,B,G,H)
\tkzDrawCircles(O_1,C O_2,B O_0,B)
\tkzDrawSegments(H,C B,K A,L)
\tkzDrawPoints(A,B,C,K,E,F,G,H,O_0,O_1,O_2,R,S,T,L)
\tkzLabelPoints(A,B,C,K,E,F,G,H,O_0,O_1,O_2,R,S,T,L)
\end{tikzpicture}

```

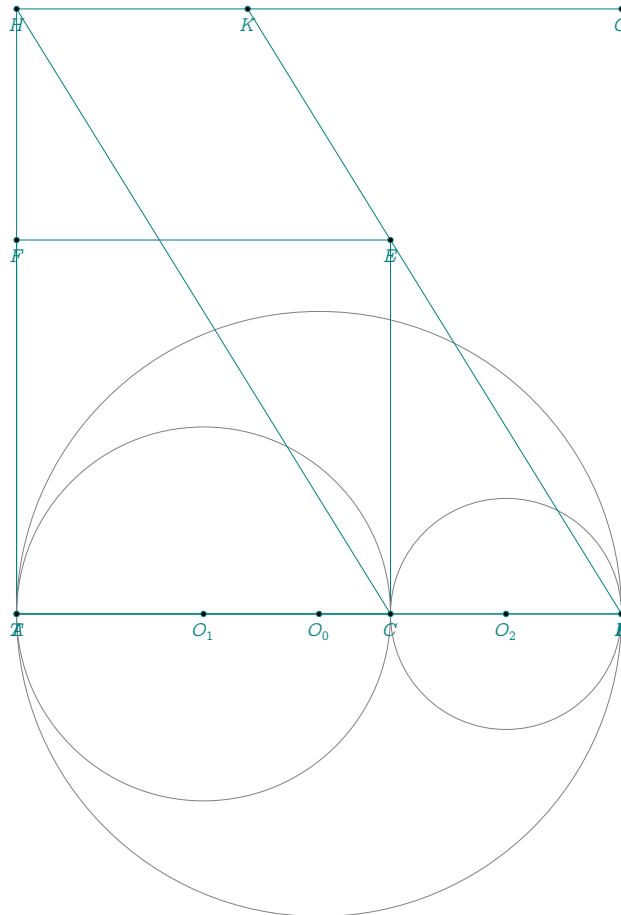

20.11 Director circle

```

\begin{tkzelements}
scale      = .5
z.O        = point: new (0 , 0)
z.F1       = point: new (4 , 0)
z.F2       = point: new (-4 , 0)
z.H        = point: new (4*math.sqrt(2) , 0)
E          = ellipse: foci (z.F2,z.F1,z.H)
a,b        = E.Rx, E.Ry
z.A        = E.covertex
T          = triangle: new (z.H,z.O,z.A)
z.P        = T: parallelogram ()
C          = circle: new (z.O,z.P)
z.L        = C: point (0.25)
L.J,L.K    = E: tangent_from (z.L)
z.J        = L.J.pb
z.K        = L.K.pb
\end{tkzelements}
\begin{tikzpicture}
\tkzGetNodes
\tkzDrawPoints(F1,F2,O)
\tkzDrawCircles[teal](O,P)
\tkzDrawPolygon(H,O,A,P)
\tkzDrawEllipse[red](O,\tkzUseLua{a},\tkzUseLua{b},0)
\tkzDrawSegments[orange](O,P O,L L,J L,K)
\tkzDrawPoints(F1,F2,O,H,A,P,L,J,K)
\tkzLabelPoints(F1,F2,O,H,A,P,L,J,K)
\tkzMarkRightAngles(A,P,H J,L,K)
\end{tikzpicture}

```

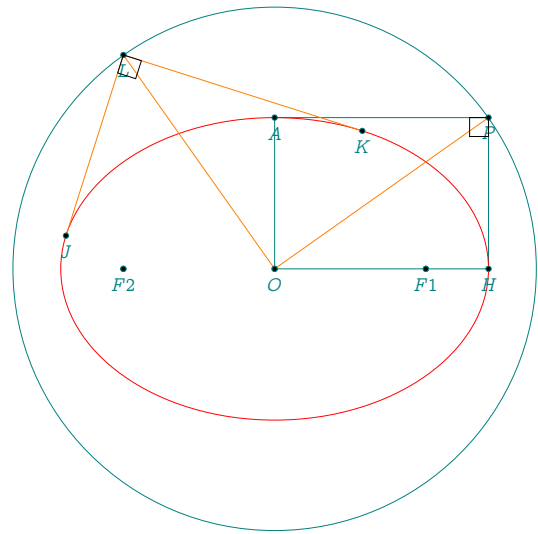

20.12 Gold division

```

\begin{tkzelements}
z.A        = point: new (0,0)
z.B        = point: new (2.5,0)
L.AB       = line: new (z.A,z.B)
C.AB       = circle: new (z.A,z.B)
C.BA       = circle: new (z.B,z.A)
z.J        = L.AB: midpoint ()
L.JB       = line:new (z.J,z.B)
z.F,z.E    = intersection (C.AB , C.BA)
z.I,_      = intersection (L.AB , C.BA)
z.K        = L.JB : midpoint ()
L.mediator = L.JB: mediator ()
z.G        = intersection (L.mediator,C.BA)
L.EG       = line:new (z.E,z.G)
z.C        = intersection (L.EG,L.AB)
z.O        = C.AB: antipode (z.B)
\end{tkzelements}
\begin{tikzpicture}
\tkzGetNodes

```

```

\tkzDrawArc[delta=5](O,B)(G)
\tkzDrawCircles(A,B B,A)
\tkzDrawSegments(A,E B,E O,I)
\tkzDrawSegments[red](J,E A,G G,I K,G E,G)
\tkzMarkSegments[mark=s||](A,E B,E O,A)
\tkzDrawPoints(A,B,C,E,I,J,G,O,K)
\tkzLabelPoints(A,B,C,E,I,J,G,O,K)
\end{tikzpicture}

```

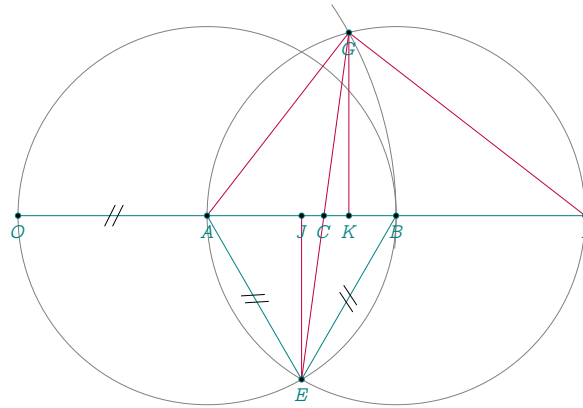

20.13 Ellipse

```

\begin{tkzelements}
z.C      = point: new (3 , 2)
z.A      = point: new (5 , 1)
L.CA     = line : new (z.C,z.A)
z.b      = L.CA.north_pa
L        = line : new (z.C,z.b)
z.B      = L : point (0.5)
E        = ellipse: new (z.C,z.A,z.B)
a        = E.Rx
b        = E.Ry
slope    = math.deg(E.slope)
\end{tkzelements}
\begin{tikzpicture}
\tkzGetNodes
\tkzDrawCircles[teal](C,A)
\tkzDrawEllipse[red](C,\tkzUseLua{a},\tkzUseLua{b},\tkzUseLua{slope})
\tkzDrawPoints(C,A,B,b)
\tkzLabelPoints(C,A,B)
\end{tikzpicture}

```

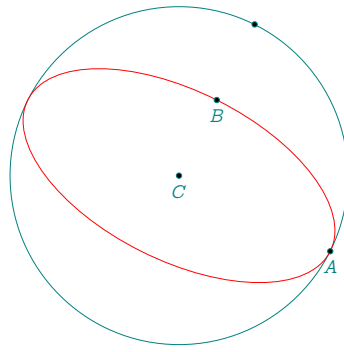

20.14 Ellipse with radii

```

\begin{tkzelements}
z.C      = point: new (0 , 4)
z.B      = point: new (4 , 0)
z.D      = point: new (2 , 6)
b        = math.sqrt(8)
a        = math.sqrt(32)
ang      = math.deg(math.pi/4)
E        = ellipse: radii (z.C,a,b,math.pi/4)
z.V      = E : point (0)
z.CoV    = E : point (0.25)
\end{tkzelements}
\begin{tikzpicture}
\tkzGetNodes
\tkzDrawEllipse[blue](C,\tkzUseLua{a},\tkzUseLua{b},\tkzUseLua{ang})
\tkzDrawPoints(C,V,CoV)
\end{tikzpicture}

```

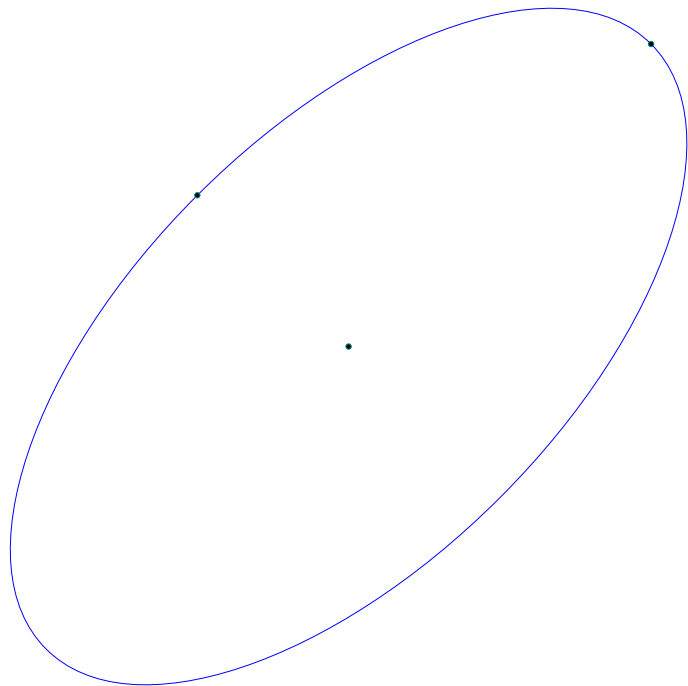

20.15 Ellipse_with_foci

```

\begin{tkzelements}
  local e
  e      = .8
  z.A    = point: new (2 , 3)
  z.B    = point: new (5 , 4)
  z.K    = point: new (6, 7)
  L.AB   = line: new (z.A,z.B)
  z.C    = L.AB.mid
  c      = point.abs(z.B-z.C)
  a      = c/e
  b      = math.sqrt (a^2-c^2)
  z.V    = z.C + a*(z.B-z.C)/point.abs(z.B-z.C)
  E      = ellipse: foci (z.A,z.B,z.V)
  z.cV   = E.covertex
  ang    = math.deg(E.slope)
  L.ta,L.tb = E: tangent_from (z.K)
  z.F    = L.ta.pb
  z.G    = L.tb.pb
\end{tkzelements}
\begin{tikzpicture}
  \tkzGetNodes
  \tkzDrawPoints(A,B,C,K,F,G,V,cV)
  \tkzLabelPoints(A,B,C,K,F,G,V,cV)
  \tkzDrawEllipse[teal](C,\tkzUseLua{a},\tkzUseLua{b},\tkzUseLua{ang})
  \tkzDrawLines(K,F K,G)
\end{tikzpicture}

```

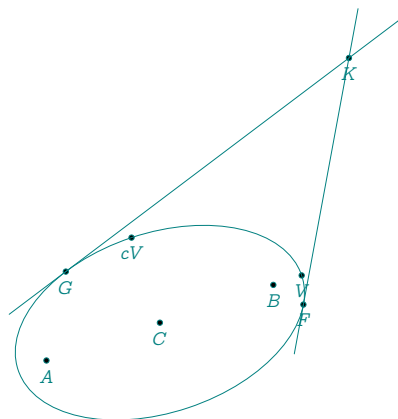

20.16 Euler relation

```

\begin{tkzelements}
  scale  = .75
  z.A    = point: new (0 , 0)
  z.B    = point: new (5 , 0)
  z.C    = point: new (-.4 , 4)
  T.ABC  = triangle: new (z.A,z.B,z.C)
  z.J,z.K = get_points(T.ABC: ex_circle (2))
  z.X ,z.Y,z.K = T.ABC : projection (z.J)
  z.I,z.H = get_points(T.ABC : in_circle())
  z.O    = T.ABC.circumcenter
  C.OA  = circle : new (z.O,z.A)
  T.IBA = triangle: new (z.I,z.B,z.A)

```



```

z.w          = T.IBA.circumcenter
L.Ow        = line : new (z.O,z.w)
_,z.E       = intersection (L.Ow, C.OA)
\end{tkzelements}
\begin{tikzpicture}
\tkzGetNodes
\tkzDrawArc(J,X)(Y)
\tkzDrawCircles(I,H O,A)
\tkzDrawCircle[red](w,I)
\tkzDrawLines(Y,C A,B X,C E,w E,B)
\tkzDrawSegments[blue](J,C J,K I,H I,O w,B)
\tkzDrawPoints(A,B,C,I,J,E,w,H,K,O)
\tkzLabelPoints(A,B,C,J,I,w,H,K,E,O)
\tkzMarkRightAngles[fill=gray!20,opacity=.4](C,H,I A,K,J)
\end{tikzpicture}

```

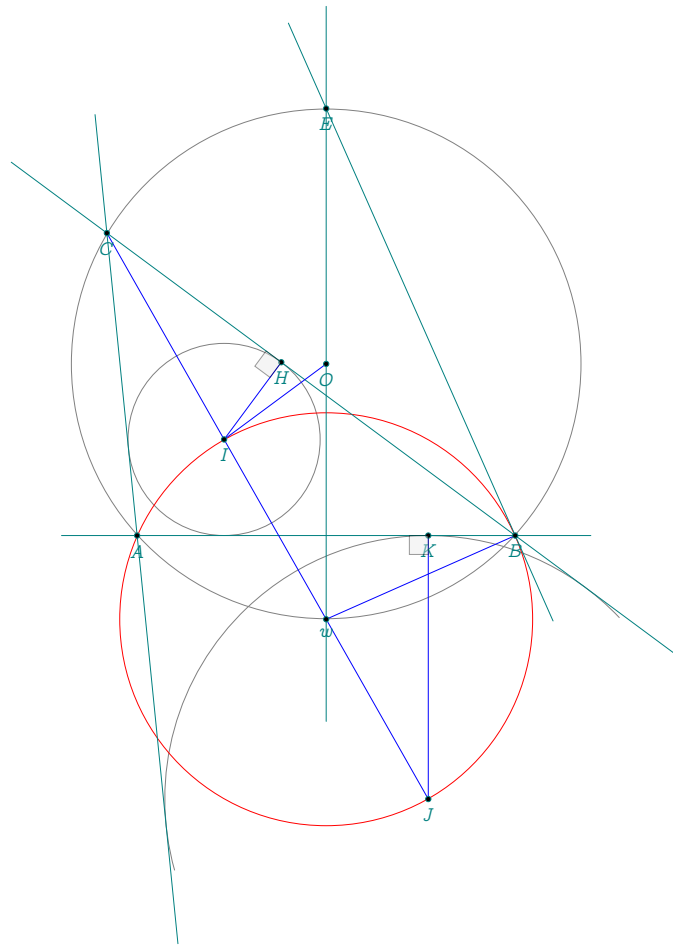

20.17 External angle

```

\begin{tkzelements}
  scale =.8
  z.A   = point: new (0 , 0)
  z.B   = point: new (5 , 0)
  z.C   = point: new (-2 , 4)
  T.ABC = triangle: new (z.A,z.B,z.C)
  T.ext = T.ABC: excentral ()
  z.O   = T.ABC.circumcenter
  z.D   = intersection (T.ext.ab,T.ABC.ab)
  z.E   = z.C: symmetry (z.B)
\end{tkzelements}
\begin{tikzpicture}
  \tkzGetNodes
  \tkzDrawPolygon(A,B,C)
  \tkzDrawLine[purple,add=0 and .5](B,C)
  \tkzDrawSegment[purple](A,D)
  \tkzDrawSegment[orange](C,D)
  \tkzFillAngles[purple!30,opacity=.2](D,C,A E,C,D)
  \tkzMarkAngles[mark=|](D,C,A E,C,D)
  \tkzDrawPoints(A,...,D)
  \tkzLabelPoints[above](C)
  \tkzLabelPoints(A,B,D)
\end{tikzpicture}

```

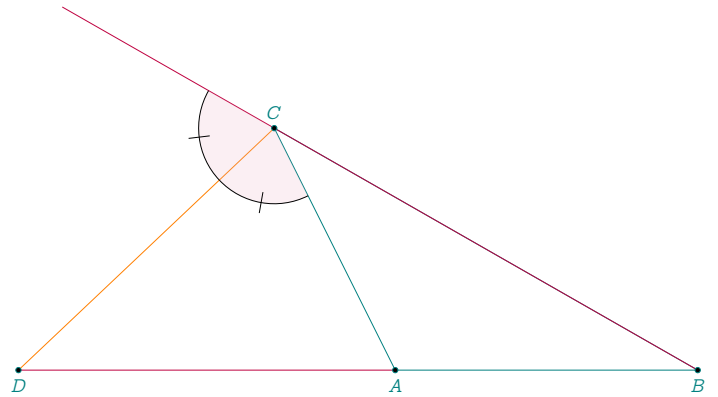

20.18 Internal angle

```

\begin{tkzelements}
  scale = .8
  z.A   = point: new (0 , 0)
  z.B   = point: new (6 , 0)
  z.C   = point: new (1 , 5)
  T     = triangle: new (z.A,z.B,z.C)
  z.I   = T.incenter
  L.AI  = line: new (z.A,z.I)
  z.D   = intersection (L.AI, T.bc)
  L.LL  = T.ab: ll_from (z.C)
  L.AD  = line: new (z.A,z.D)
  z.E   = intersection (L.LL,L.AD)
\end{tkzelements}
\begin{tikzpicture}
  \tkzGetNodes
  \tkzDrawPolygon(A,B,C)
  \tkzDrawLine[purple](C,E)
  \tkzDrawSegment[purple](A,E)
  \tkzFillAngles[purple!30,opacity=.4](B,A,C C,E,D)
  \tkzMarkAngles[mark=|](B,A,D D,A,C C,E,D)
  \tkzDrawPoints(A,...,E)
  \tkzLabelPoints(A,B)
  \tkzLabelPoints[above](C,D,E)
  \tkzMarkSegments(A,C C,E)
\end{tikzpicture}

```

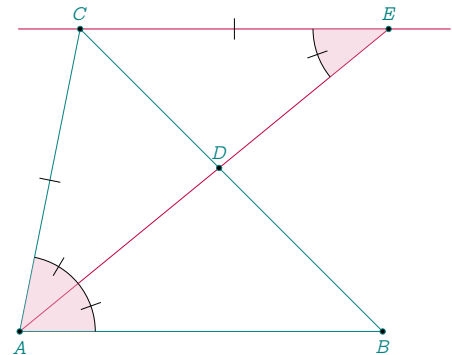

20.19 Feuerbach theorem

```

\begin{tkzelements}
  scale      = 1.5
  z.A        = point: new (0 , 0)
  z.B        = point: new (5 , -.5)
  z.C        = point: new (-.5 , 3)
  T.ABC      = triangle: new (z.A,z.B,z.C)
  z.O        = T.ABC.circumcenter
  z.N        = T.ABC.eulercenter
  z.I,z.K    = get_points(T.ABC: in_circle())
  z.H        = T.ABC.ab : projection (z.I)
  z.Ap,
  z.Bp,
  z.Cp      = get_points (T.ABC : medial ())
  C.IH      = circle:new (z.I,z.H)
  C.NAp     = circle:new (z.N,z.Ap)
  C.OA      = circle:new (z.O,z.A)
  z.U        = C.OA.south
  z.L        = C.NAp.south
  z.M        = C.NAp.north
  z.X        = T.ABC.ab: projection (z.C)
  L.CU      = line: new (z.C,z.U)
  L.ML      = line: new (z.M,z.L)
  z.P        = L.CU: projection (z.A)
  z.Q        = L.CU: projection (z.B)
  L.LH      = line: new (z.L,z.H)
  z.F        = intersection (L.LH,C.IH) -- feuerbach
\end{tkzelements}

```

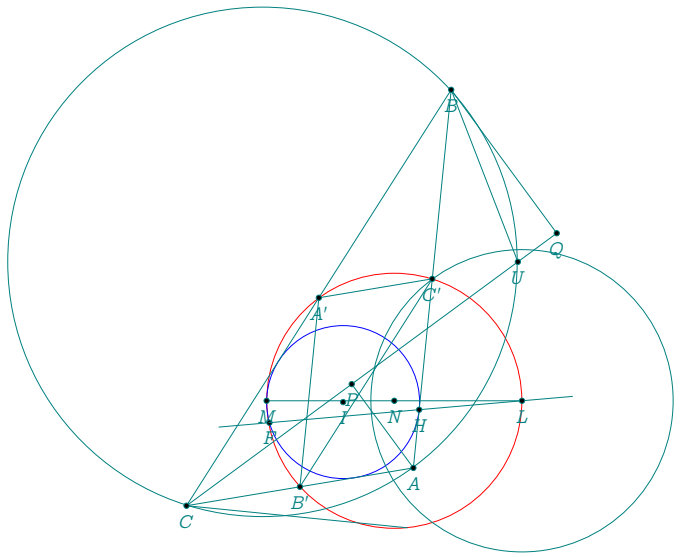

```

\begin{tikzpicture}
  \tkzGetNodes
  \tkzDrawLine(L,F)
  \tkzDrawCircle[red] (N,A')
  \tkzDrawCircle[blue] (I,H)
  \tkzDrawCircles[teal] (O,A L,C')
  \tkzDrawSegments(M,L B,U Q,C C,X A,P B,Q)
  \tkzDrawPolygons(A,B,C A',B',C')
  \tkzDrawPoints(A,B,C,N,H,A',B',C',U,L,M,P,Q,F,I)
  \tkzLabelPoints(A,B,C,N,H,A',B',C',U,L,M,P,Q,F,I)
\end{tikzpicture}

```

20.20 Gold ratio with segment

```

\begin{tkzelements}
  z.A      = point: new (0 , 0)
  z.B      = point: new (8 , 0)
  L.AB     = line: new (z.A,z.B)
  z.X,z.Y  = L.AB: square ()
  L.BX     = line: new (z.B,z.X)
  z.M      = L.BX.mid
  C.MA     = circle: new (z.M,z.A)
  _,z.K    = intersection (L.BX,C.MA)
  L.AK     = line: new (z.Y,z.K)
  z.C      = intersection (L.AK,L.AB)
\end{tkzelements}
\begin{tikzpicture}
  \tkzGetNodes
  \tkzDrawLines(A,B X,K)
  \tkzDrawLine[teal](Y,K)
  \tkzDrawPoints(A,B,C,X,Y,M,K)
  \tkzDrawArc[delta=20](M,A)(K)
  \tkzLabelPoints(A,B,C)
\end{tikzpicture}

```

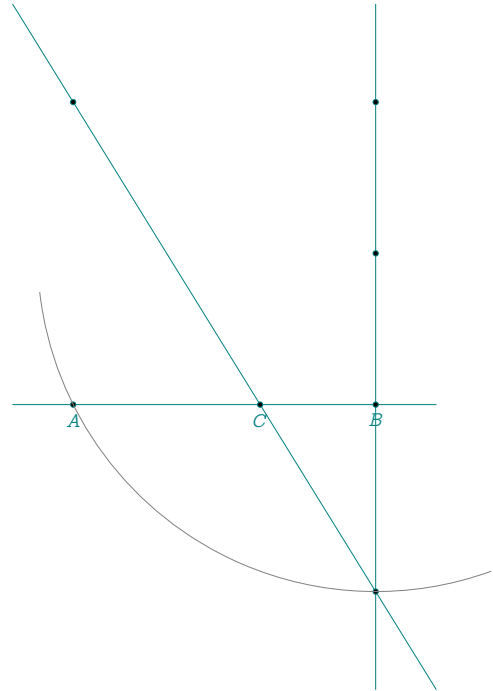

20.21 Gold Arbelos

```

\begin{tkzelements}
  scale    = .6
  z.A      = point: new (0 , 0)
  z.C      = point: new (6 , 0)
  L.AC     = line: new (z.A,z.C)
  z.x,z.y  = L.AC: square ()
  z.O_1    = L.AC . mid
  C        = circle: new (z.O_1,z.x)
  z.B      = intersection (L.AC,C)
  L.CB     = line: new (z.C,z.B)
  z.O_2    = L.CB.mid
  L.AB     = line: new (z.A,z.B)
  z.O_0    = L.AB.mid
\end{tkzelements}
\begin{tikzpicture}
  \tkzGetNodes
  \tkzDrawCircles(O_1,C O_2,B O_0,B)
  \tkzDrawPoints(A,C,B,O_1,O_2,O_0)
  \tkzLabelPoints(A,C,B)
\end{tikzpicture}

```

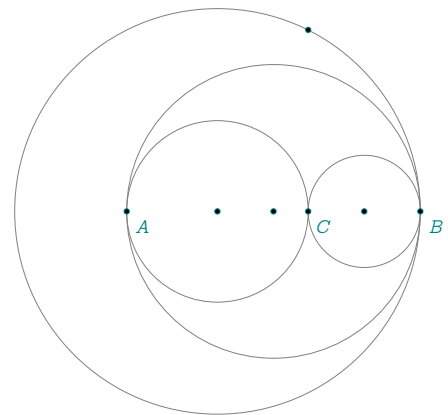

20.23 Harmonic division v2

```

\begin{tkzelements}
  scale = .5
  z.A = point: new (0 , 0)
  z.B = point: new (6 , 0)
  z.D = point: new (12 , 0)
  L.AB = line: new (z.A,z.B)
  z.X = L.AB.north_pa
  L.XB = line: new (z.X,z.B)
  z.E = L.XB.mid
  L.ED = line: new (z.E,z.D)
  L.AX = line: new (z.A,z.X)
  L.AE = line: new (z.A,z.E)
  z.F = intersection (L.ED,L.AX)
  L.BF = line: new (z.B,z.F)
  z.G = intersection (L.AE,L.BF)
  L.GX = line: new (z.G,z.X)
  z.C = intersection (L.GX,L.AB)
\end{tkzelements}
\begin{tikzpicture}
  \tkzGetNodes
  \tkzDrawLines(A,D A,E B,F D,F X,A X,B X,C)
  \tkzDrawPoints(A,...,G,X)
  \tkzLabelPoints(A,...,G,X)
\end{tikzpicture}

```

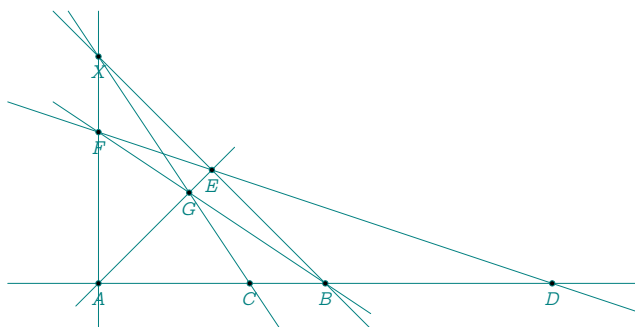

20.24 Menelaus

```

\begin{tkzelements}
  z.A = point: new (0 , 0)
  z.B = point: new (6 , 0)
  z.C = point: new (5 , 4)
  z.P = point: new (-1 , 0)
  z.X = point: new (6 , 3)
  L.AC = line: new (z.A,z.C)
  L.PX = line: new (z.P,z.X)
  L.BC = line: new (z.B,z.C)
  z.Q = intersection (L.AC,L.PX)
  z.R = intersection (L.BC,L.PX)
\end{tkzelements}
\begin{tikzpicture}
  \tkzGetNodes
  \tkzDrawPolygon(A,B,C)
  \tkzDrawLine[new] (P,R)
  \tkzDrawLines(P,B A,C B,C)
  \tkzDrawPoints(P,Q,R,A,B,C)
  \tkzLabelPoints(A,B,C,P,Q,R)
\end{tikzpicture}

```

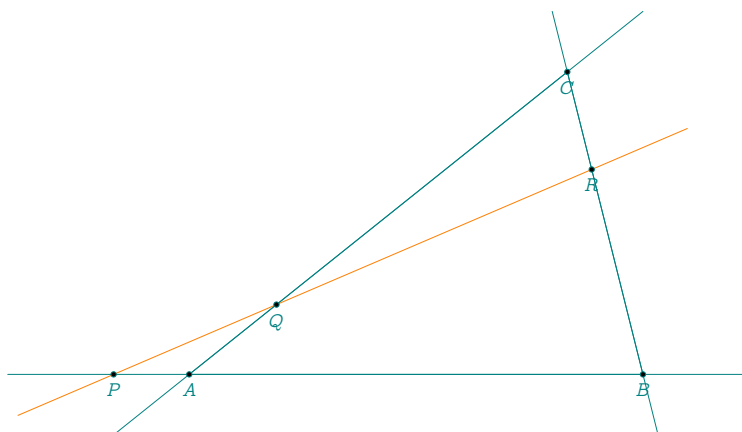

20.25 Radical axis v1

```

\begin{tkzelements}
scale      = .75
z.X        = point : new (0,0)
z.B        = point : new (2,2)
z.Y        = point : new (7,1)
z.Ap       = point : new (8,-1)
L.XY       = line :   new (z.X,z.Y)
C.XB       = circle : new (z.X,z.B)
C.YAp      = circle : new (z.Y,z.Ap)
z.E,z.F    = get_points (C.XB : radical_axis (C.YAp))
z.A        = C.XB : point (0.4)
T.ABAp     = triangle: new (z.A,z.B,z.Ap)
z.O        = T.ABAp.circumcenter
C.OAp      = circle : new (z.O,z.Ap)
_,z.Bp     = intersection (C.OAp,C.YAp)
L.AB       = line : new (z.A,z.B)
L.ApBp     = line : new (z.Ap,z.Bp)
z.M        = intersection (L.AB,L.ApBp)
z.H        = L.XY : projection (z.M)
\end{tkzelements}
\begin{tikzpicture}
  \tkzGetNodes
  \tkzDrawCircles(X,B Y,A')
  \tkzDrawArc[dashed,delta=30](O,A')(A)
  \tkzDrawPoints(A,B,A',B',M,H,X,Y,O,E,F)
  \tkzDrawLines[red](A,M A',M X,Y E,F)
  \tkzDrawLines[red,add=1 and 3](M,H)
\end{tikzpicture}

```

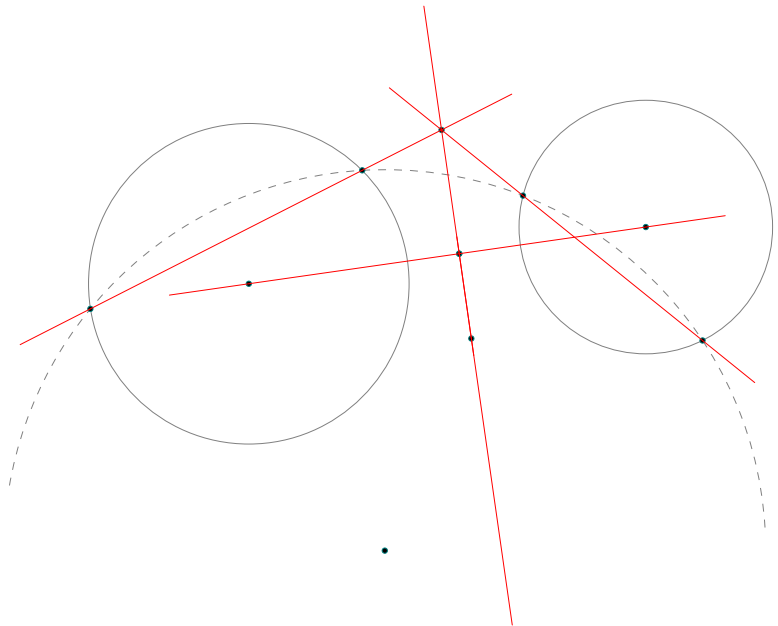

20.26 Radical axis v2

```

\begin{tkzelements}
z.O        = point : new (-1,0)
z.Op       = point : new (4,-1)

```

```

z.O      = point : new (0,2)
z.D      = point : new (4,0)
C.OB     = circle :   new (z.O,z.B)
C.OpD    = circle :   new (z.Op,z.D)
L.EF     = C.OB : radical_axis (C.OpD)
z.E,z.F  = get_points (L.EF)
z.M      = L.EF : point (2)
L.MT,L.MTp = C.OB : tangent_from (z.M)
_,z.T    = get_points (L.MT)
_,z.Tp   = get_points (L.MTp)
L.MK,L.MKp = C.OpD : tangent_from (z.M)
_,z.K    = get_points (L.MK)
_,z.Kp   = get_points (L.MKp)
\end{tkzelements}
\begin{tikzpicture}
\tkzGetNodes
\tkzDrawCircles(O,B O',D)
\tkzDrawLine[add=1 and 2](E,F)
\tkzDrawLine[add=.5 and .5](O,O')
\tkzDrawSegments(M,T M,T' M,K M,K')
\tkzDrawCircle(M,T)
\tkzDrawPoints(O,O',T,M,T',K,K')
\tkzLabelPoints(O,O',T,T',K,K',M)
\end{tikzpicture}

```

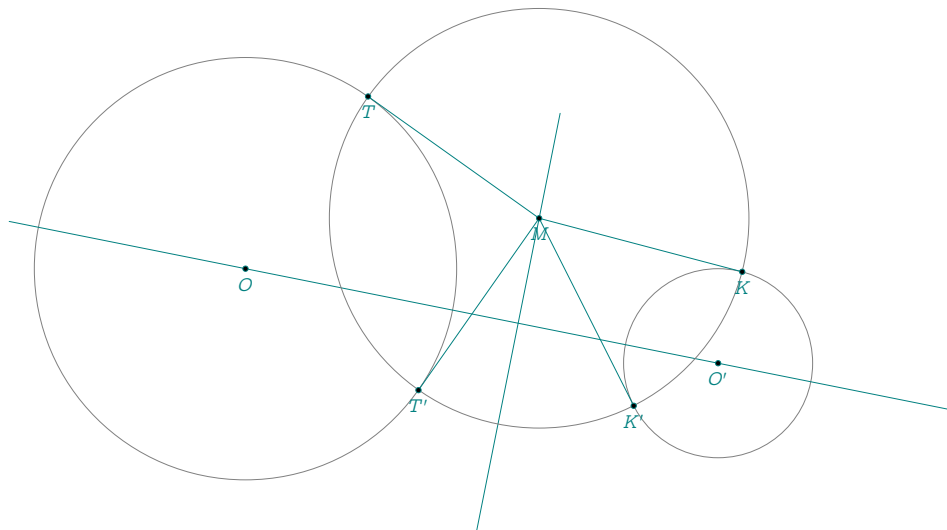

20.27 Radical axis v3

```

\begin{tkzelements}
z.O      = point : new (0,0)
z.B      = point : new (4,0)
z.Op     = point : new (6,0)
C.OB     = circle :   new (z.O,z.B)
C.OpB    = circle :   new (z.Op,z.B)
L.EF     = C.OB : radical_axis (C.OpB)
z.E,z.F  = get_points(L.EF)
z.M      = L.EF : point (2)
_,L      = C.OB : tangent_from (z.M)
_,z.T    = get_points (L)

```



```

L,_      = C.OpB : tangent_from (z.M)
_,z.Tp   = get_points (L)
\end{tkzelements}
\begin{tikzpicture}
\tkzGetNodes
\tkzDrawCircles(O,B O',B)
\tkzDrawSegments(M,T M,T')
\tkzDrawLine[add=.5 and 1](E,F)
\tkzDrawLine[add=.5 and .5](O,O')
\tkzDrawPoints(O,B,O',E,F,M,T,T')
\tkzLabelPoints(O,O',B,E,F,T,T')
\tkzDrawArc(M,T')(T)
\end{tikzpicture}

```

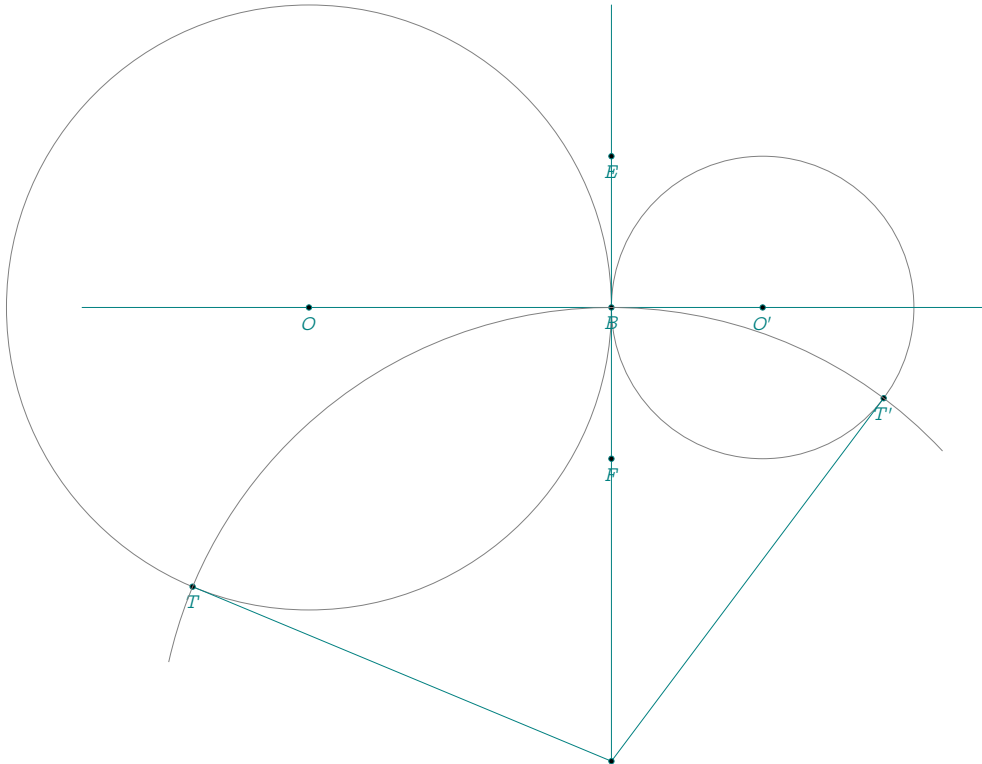

20.28 Radical axis v4

```

\begin{tkzelements}
z.O      = point : new (0,0)
z.B      = point : new (5,0)
z.Op     = point : new (3,0)
C.OB    = circle : new (z.O,z.B)
C.OpB   = circle : new (z.Op,z.B)
L.EF    = C.OB : radical_axis (C.OpB)
z.E,z.F = get_points(L.EF)
z.M      = L.EF : point (1.5)
L,_      = C.OB : tangent_from (z.M)
_,z.T    = get_points (L)
L,_      = C.OpB : tangent_from (z.M)
_,z.Tp   = get_points (L)
\end{tkzelements}

```

20.29 Radical center

```

\begin{tkzelements}
z.O      = point : new (0,0)
z.x      = point : new (1,0)
z.y      = point : new (4,0)
z.z      = point : new (2,0)
z.Op     = point : new (4,2)
z.P      = point : new (2,2.5)
C.Ox     = circle : new (z.O,z.x)
C.Pz     = circle : new (z.P,z.z)
C.Opy    = circle : new (z.Op,z.y)
z.ap,z.a = intersection (C.Ox,C.Pz)
z.bp,z.b = intersection (C.Opy,C.Pz)
L.aap    = line : new (z.a,z.ap)
L.bbp    = line : new (z.b,z.bp)
z.X      = intersection (L.aap,L.bbp)
-- or z.X = radical_center(C.Ox,C.Pz,C.Opy)
L.OOp    = line : new (z.O,z.Op)
z.H      = L.OOp : projection (z.X)
\end{tkzelements}
\begin{tikzpicture}
\tkzGetNodes
\tkzDrawCircles(O,a O',b P,z)
\tkzDrawLines[red](a,X b',X H,X O,O')
\tkzDrawPoints(O,O',P,a,a',b,b',X,H)
\tkzLabelPoints[below right](O,O',P,H)
\end{tikzpicture}

```

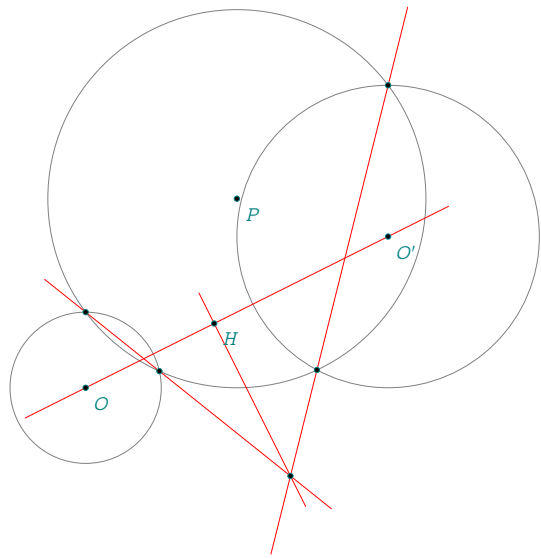

20.30 Radical circle

```

\begin{tkzelements}
  scale      = .25
  z.A        = point: new (0,0)
  z.B        = point: new (6,0)
  z.C        = point: new (0.8,4)
  T.ABC      = triangle : new ( z.A,z.B,z.C )
  C.exa      = T.ABC : ex_circle ()
  z.I_a,z.Xa = get_points (C.exa)
  C.exb      = T.ABC : ex_circle (1)
  z.I_b,z.Xb = get_points (C.exb)
  C.exc      = T.ABC : ex_circle (2)
  z.I_c,z.Xc = get_points (C.exc)
  C.ortho    = radical_circle (C.exa,C.exb,C.exc)
  z.w,z.a    = get_points (C.ortho)
\end{tkzelements}
\begin{tikzpicture}
  \tkzGetNodes
  \tkzDrawPolygon(A,B,C)
  \tkzDrawCircles(I_a,Xa I_b,Xb I_c,Xc)
  \tkzDrawCircles[red,thick](w,a)
  \tkzDrawPoints(A,B,C)
  \tkzLabelPoints(A,B,C)
\end{tikzpicture}

```

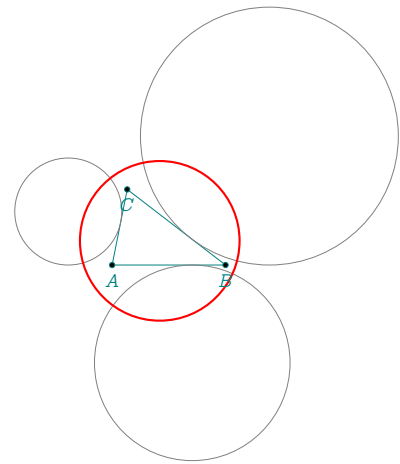

20.31 Hexagram

```

\begin{tkzelements}
  z.A        = point: new (0 , 0)
  z.B        = point: new (5 , 1)
  L.AB       = line : new (z.A,z.B)
  z.C        = point: new (.8 , 3)
  T.ABC      = triangle: new (z.A,z.B,z.C)
  z.N        = T.ABC.eulercenter
  z.G        = T.ABC.centroid
  z.O        = T.ABC.circumcenter
  z.H        = T.ABC.orthocenter
  z.Ma,z.Mb,z.Mc = get_points (T.ABC : medial ())
  z.Ha,z.Hb,z.Hc = get_points (T.ABC : orthic ())
  z.Ea,z.Eb,z.Ec = get_points (T.ABC: extouch())
  L.euler    = T.ABC : euler_line ()
  C.circum   = T.ABC : circum_circle ()
  C.euler    = T.ABC : euler_circle ()
  z.I,z.J    = intersection (L.euler,C.euler)
  E          = ellipse: foci (z.H,z.O,z.I)
  a          = E.Rx
  b          = E.Ry
  ang        = math.deg(E.slope)
  L.AH       = line: new (z.A,z.H)
  L.BH       = line: new (z.B,z.H)
  L.CH       = line: new (z.C,z.H)
  z.X        = intersection (L.AH,C.circum)
  _,z.Y      = intersection (L.BH,C.circum)

```

```

_,z.Z      = intersection (L.CH,C.circum)
L.BC      = line: new (z.B,z.C)
L.XO      = line: new (z.X,z.O)
L.YO      = line: new (z.Y,z.O)
L.ZO      = line: new (z.Z,z.O)
z.x       = intersection (L.BC,L.XO)
z.U       = intersection (L.XO,E)
_,z.V     = intersection (L.YO,E)
_,z.W     = intersection (L.ZO,E)
\end{tkzelements}
\begin{tikzpicture}
\tkzGetNodes
\tkzDrawPolygon(A,B,C)
\tkzDrawCircles[red](N,Ma O,A)
\tkzDrawSegments(A,X B,Y C,Z B,Hb C,Hc X,O Y,O Z,O)
\tkzDrawPolygon[red](U,V,W)
\tkzLabelPoints[red](U,V,W)
\tkzLabelPoints(A,B,C,X,Y,Z)
\tkzDrawLine[blue](I,J)
\tkzLabelPoints[blue,right](O,N,G,H,I,J)
\tkzDrawPoints(I,J,U,V,W)
\tkzDrawPoints(A,B,C,N,G,H,O,X,Y,Z,Ma,Mb,Mc,Ha,Hb,Hc)
\tkzDrawEllipse[blue](N,\tkzUseLua{a},\tkzUseLua{b},\tkzUseLua{ang})
\end{tikzpicture}

```

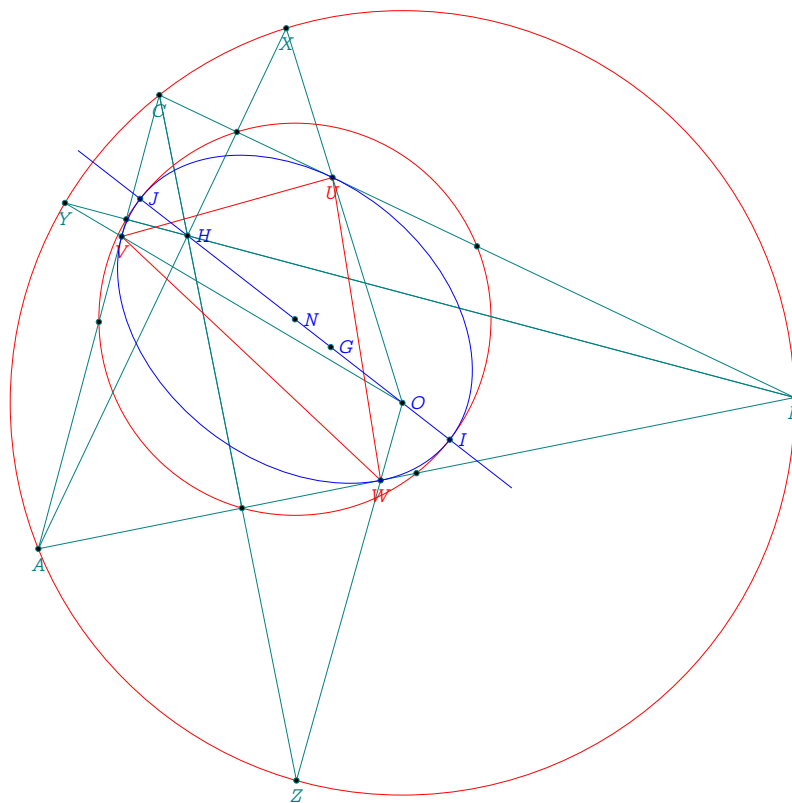

20.32 Gold Arbelos properties

```

\begin{tkzelements}

```

```

z.A      = point : new(0,0)
z.B      = point : new(10,0)
z.C      = gold_segment_ (z.A,z.B)
L.AB     = line:new (z.A,z.B)
z.O_1    = L.AB.mid
L.AC     = line:new (z.A,z.C)
z.O_2    = L.AC.mid
L.CB     = line:new (z.C,z.B)
z.O_3    = L.CB.mid
C1       = circle:new (z.O_1,z.B)
C2       = circle:new (z.O_2,z.C)
C3       = circle:new (z.O_3,z.B)
z.Q      = C2.north
z.P      = C3.north
L1       = line:new (z.O_2,z.O_3)
z.M_0    = L1:harmonic_ext (z.C)
L2       = line:new (z.O_1,z.O_2)
z.M_1    = L2:harmonic_int (z.A)
L3       = line:new (z.O_1,z.O_3)
z.M_2    = L3:harmonic_int (z.B)
Lbq      = line:new (z.B,z.Q)
Lap      = line:new (z.A,z.P)
z.S      = intersection (Lbq,Lap)
z.x      = z.C: north ()
L        = line : new (z.C,z.x)
z.D,_    = intersection (L,C1)
L.CD     = line :new (z.C,z.D)
z.O_7    = L.CD.mid
C.DC     = circle: new (z.D,z.C)
z.U,z.V  = intersection (C.DC,C1)
L.UV     = line :new (z.U,z.V)
z.R ,z.S = L.UV : projection (z.O_2,z.O_3)
L.O1D    = line : new (z.O_1,z.D)
z.W      = intersection (L.UV,L.O1D)
z.O      = C.DC : inversion (z.W)
\end{tkzelements}
\begin{tikzpicture}
  \tkzGetNodes
  \tkzDrawCircles[teal](O_1,B)
  \tkzDrawSemiCircles[thin,teal](O_2,C O_3,B)
  \tkzDrawArc[purple,delta=0](D,V)(U)
  \tkzDrawCircle[new](O_7,C)
  \tkzDrawSegments[thin,purple](A,D D,B C,R C,S C,D U,V)
  \tkzDrawSegments[thin,red](O,D A,O O,B)
  \tkzDrawPoints(A,B,C,D,O_7) %,
  \tkzDrawPoints(O_1,O_2,O_3,U,V,R,S,W,O)
  \tkzDrawSegments[cyan](O_3,S O_2,R)
  \tkzDrawSegments[very thin](A,B)
  \tkzDrawSegments[cyan,thin](C,U U,D)
  \tkzMarkRightAngles[size=.2,fill=gray!40,opacity=.4](D,C,A A,D,B
    D,S,C D,W,V O_3,S,U O_2,R,U)
  \tkzFillAngles[cyan!40,opacity=.4](B,A,D A,D,O_1
    C,D,B D,C,R B,C,S A,R,O_2)
  \tkzFillAngles[green!40,opacity=.4](S,C,D W,R,D
    D,B,C R,C,A O_3,S,B)
  \tkzLabelPoints[below](C,O_2,O_3,O_1)
  \tkzLabelPoints[above](D)

```

```

\tkzLabelPoints[below](O)
\tkzLabelPoints[below left](A)
\tkzLabelPoints[above left](R)
\tkzLabelPoints[above right](S)
\tkzLabelPoints[left](V)
\tkzLabelPoints[below right](B,U,W,O_7)
\end{tikzpicture}

```

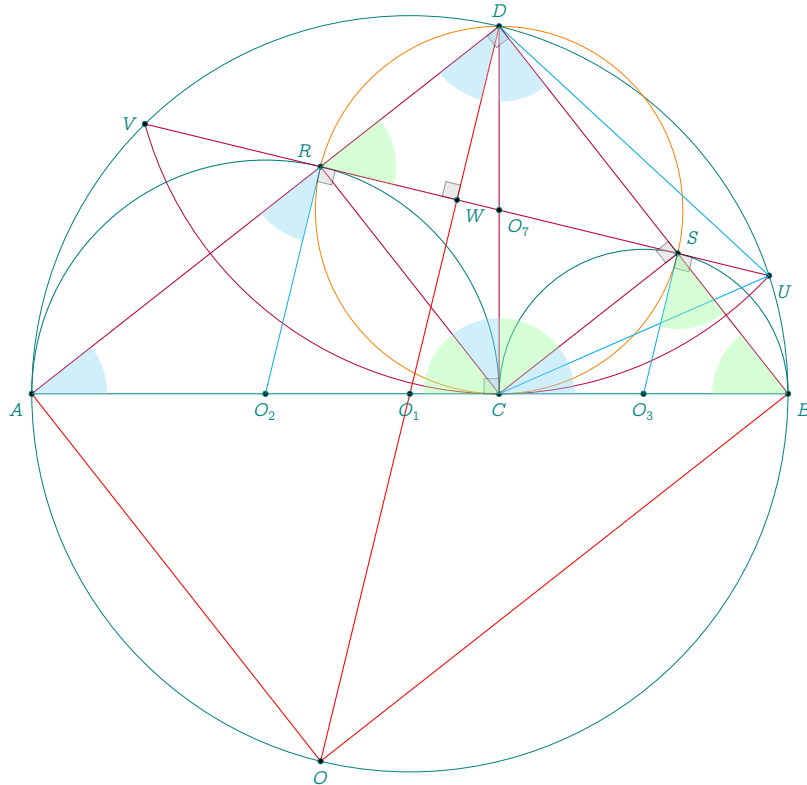

20.33 Apollonius circle v1 with inversion

```

\begin{tkzelements}
  scale = .7
  z.A = point: new (0,0)
  z.B = point: new (6,0)
  z.C = point: new (0.8,4)
  T.ABC = triangle : new ( z.A,z.B,z.C )
  z.N = T.ABC.eulercenter
  z.Ea,z.Eb,z.Ec = get_points ( T.ABC : feuerbach () )
  z.Ja,z.Jb,z.Jc = get_points ( T.ABC : excentral () )
  z.S = T.ABC : spieker_center ()
  C.JaEa = circle : new ( z.Ja,z.Ea )
  C.ortho = circle : radius ( z.S,math.sqrt(C.JaEa : power ( z.S ) ) )
  z.a = C.ortho.south
  C.euler = T.ABC: euler_circle ()
  C.apo = C.ortho : inversion ( C.euler )
  z.O = C.apo.center
  z.xa,z.xb,z.xc = C.ortho : inversion ( z.Ea,z.Eb,z.Ec )
\end{tkzelements}
\begin{tikzpicture}

```

```

\tkzGetNodes
\tkzDrawCircles[red](O,xa N,Ea)
\tkzFillCircles[green!30!black,opacity=.3](O,xa)
\tkzFillCircles[yellow!30,opacity=.7](Ja,Ea Jb,Eb Jc,Ec)
\tkzFillCircles[teal!30!black,opacity=.3](S,a)
\tkzFillCircles[green!30,opacity=.3](N,Ea)
\tkzDrawPoints[red](Ea,Eb,Ec,xa,xb,xc,N)
\tkzClipCircle(O,xa)
\tkzDrawLines[add=3 and 3](A,B A,C B,C)
\tkzDrawCircles(Ja,Ea Jb,Eb Jc,Ec)
\tkzFillCircles[lightgray!30,opacity=.7](Ja,Ea Jb,Eb Jc,Ec)
\tkzDrawCircles[teal](S,a)
\tkzDrawPoints(A,B,C,O)
\tkzDrawPoints[teal](S)
\tkzLabelPoints(A,B,C,O,S,N)
\end{tikzpicture}

```

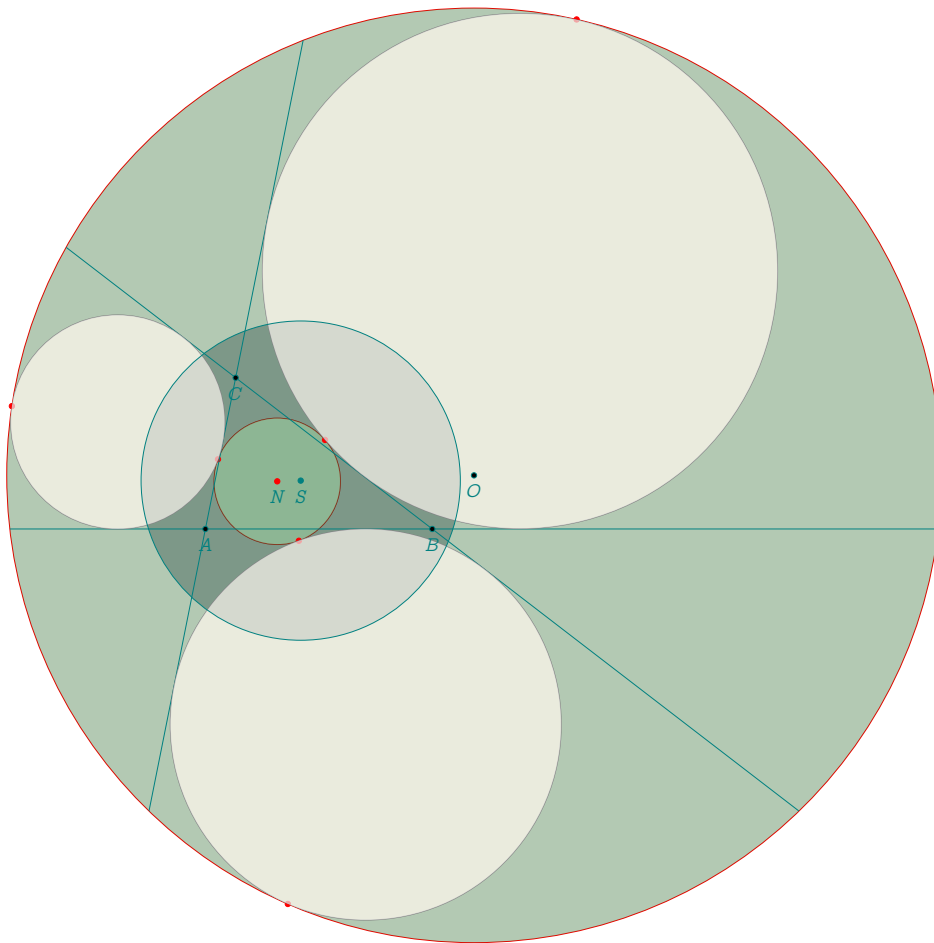

20.34 Apollonius circle v2

```

\begin{tkzelements}
  scale      = .5
  z.A        = point: new (0,0)
  z.B        = point: new (6,0)
  z.C        = point: new (0.8,4)

```



```

T.ABC      = triangle: new(z.A,z.B,z.C)
z.O        = T.ABC.circumcenter
z.H        = T.ABC.orthocenter
z.G        = T.ABC.centroid
z.L        = T.ABC: lemoine_point ()
z.S        = T.ABC: spieker_center ()
C.euler    = T.ABC: euler_circle ()
z.N,z.Ma   = get_points (C.euler)
C.exA      = T.ABC : ex_circle ()
z.Ja,z.Xa  = get_points (C.exA)
C.exB      = T.ABC : ex_circle (1)
z.Jb,z.Xb  = get_points (C.exB)
C.exC      = T.ABC : ex_circle (2)
z.Jc,z.Xc  = get_points (C.exC)
L.OL       = line: new (z.O,z.L)
L.NS       = line: new (z.N,z.S)
z.o        = intersection (L.OL,L.NS) -- center of Apollonius circle
L.NMa      = line: new (z.N,z.Ma)
L.ox       = L.NMa: ll_from (z.o)
L.MaS      = line: new (z.Ma,z.S)
z.t        = intersection (L.ox,L.MaS) -- through
\end{tkzelements}

\begin{tikzpicture}
  \tkzGetNodes
  \tkzDrawLines[add=1 and 1](A,B A,C B,C)
  \tkzDrawCircles(Ja,Xa Jb,Xb Jc,Xc o,t N,Ma) %
  \tkzClipCircle(o,t)
  \tkzDrawLines[red](o,L N,o Ma,t)
  \tkzDrawLines[cyan,add=4 and 4](Ma,N o,t)
  \tkzDrawPoints(A,B,C,Ja,Jb,Jc)
  \tkzDrawPoints[red](N,O,L,S,o,t)
  \tkzLabelPoints[right,font=\tiny](A,B,C,Ja,Jb,Jc,O,N,L,S,Ma,o)
\end{tikzpicture}

```

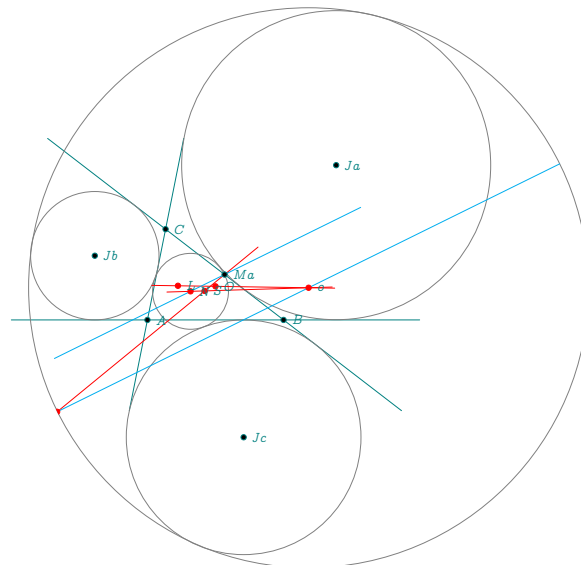

20.35 Orthogonal circles v1

```

\begin{tkzelements}
  scale      = .6
  z.C_1      = point: new (0,0)
  z.C_2      = point: new (8,0)
  z.A        = point: new (5,0)
  C          = circle: new (z.C_1,z.A)
  z.S,z.T    = get_points (C: orthogonal_from (z.C_2))
\end{tkzelements}
\begin{tikzpicture}
  \tkzGetNodes
  \tkzDrawCircles(C_1,T C_2,T)
  \tkzDrawSegments(C_1,T C_2,T)
  \tkzDrawLine(C_1,C_2)
  \tkzMarkRightAngle[fill=teal,%
opacity=.2,size=1](C_1,T,C_2)
  \tkzDrawPoints(C_1,C_2,T)
  \tkzLabelPoints(C_1,C_2)
  \tkzLabelPoints[above](T)
  \tkzLabelSegment[left](C_1,T){r}
  \tkzLabelSegments[right](C_2,T){\gamma}
  \tkzLabelSegment[below](C_1,C_2){d}
  \tkzLabelCircle[left=10pt](C_1,T)(180){Circle 1}
  \tkzLabelCircle[right=10pt](C_2,T)(180){Circle 2}
\end{tikzpicture}

```

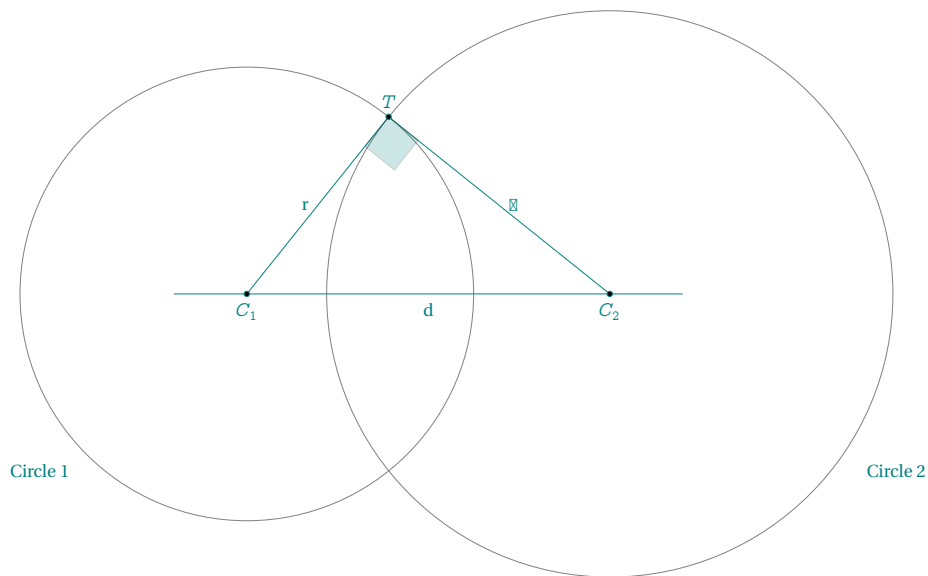

20.36 Orthogonal circles v2

```

\begin{tkzelements}
  scale      = .75
  z.O        = point: new (2,2)
  z.Op       = point: new (-4,1)
  z.P        = point: polar (4,0)
  C.OP       = circle: new (z.O,z.P)
  C.Oz1,C.Oz2 = C.OP : orthogonal_from (z.Op)
  z.z1       = C.Oz1.through
  z.z2       = C.Oz2.through

```

```

L.OP      = line : new (z.O,z.P)
C.Opz1    = circle: new (z.Op,z.z1)
L.T,L.Tp  = C.Opz1 : tangent_from (z.O)
z.T       = L.T.pb
z.Tp      = L.Tp.pb
L.OOp     = line : new (z.O,z.Op)
z.M       = L.OOp.mid
\end{tkzelements}
\begin{tikzpicture}
  \tkzGetNodes
  \tkzDrawCircle[red](O,P)
  \tkzDrawCircle[blue](O',z1)
  \tkzDrawCircle[cyan](M,T)
  \tkzDrawSegments(O',T O,T' O',T')
  \tkzDrawSegment[blue](O',T)
  \tkzDrawSegments[red](O,T O,O')
  \tkzDrawPoints(O,O',T,T',M)
  \tkzMarkRightAngle[fill=gray!10](O',T,O)
  \tkzLabelPoint[below](O){O}
  \tkzLabelPoint[above](T){T}
  \tkzLabelPoint[above](M){M}
  \tkzLabelPoint[below](T'){T'}
  \tkzLabelPoint[above left](O'){O'}
\end{tikzpicture}

```

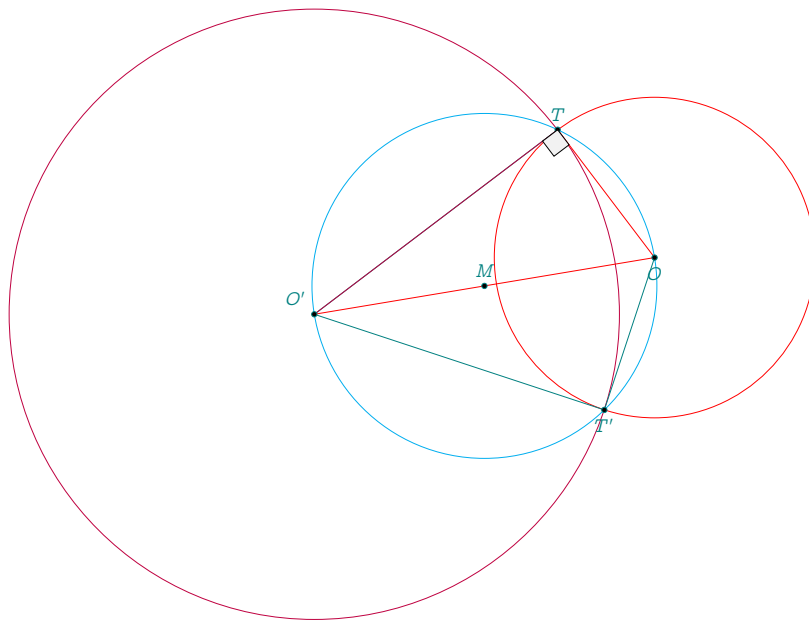

20.37 Orthogonal circle to two circles

```

\begin{tkzelements}
z.O      = point : new (-1,0)
z.B      = point : new (0,2)
z.Op     = point : new (4,-1)
z.D      = point : new (4,0)
C.OB     = circle : new (z.O,z.B)
C.OpD    = circle : new (z.Op,z.D)
z.E,z.F  = get_points (C.OB : radical_axis (C.OpD))
\end{tkzelements}

```

```

L.EF      = line : new (z.E,z.F)
z.M       = L.EF : point (2.25)
L.T,L.Tp  = C.OB : tangent_from (z.M)
L.K,L.Kp  = C.OpD : tangent_from (z.M)
z.T       = L.T.pb
z.K       = L.K.pb
z.Tp      = L.Tp.pb
z.Kp      = L.Kp.pb
\end{tkzelements}
\begin{tikzpicture}
  \tkzGetNodes
  \tkzDrawCircles(O,B O',D)
  \tkzDrawLine[add=1 and 2,cyan](E,F)
  \tkzDrawLines[add=.5 and .5,orange](O,O' O,T O,T')
  \tkzDrawSegments[cyan](M,T M,T' M,K M,K')
  \tkzDrawCircle(M,T)
  \tkzDrawPoints(O,O',T,M,T',K,K')
  \tkzLabelPoints(O,O',T,T',M,K,K')
\end{tikzpicture}

```

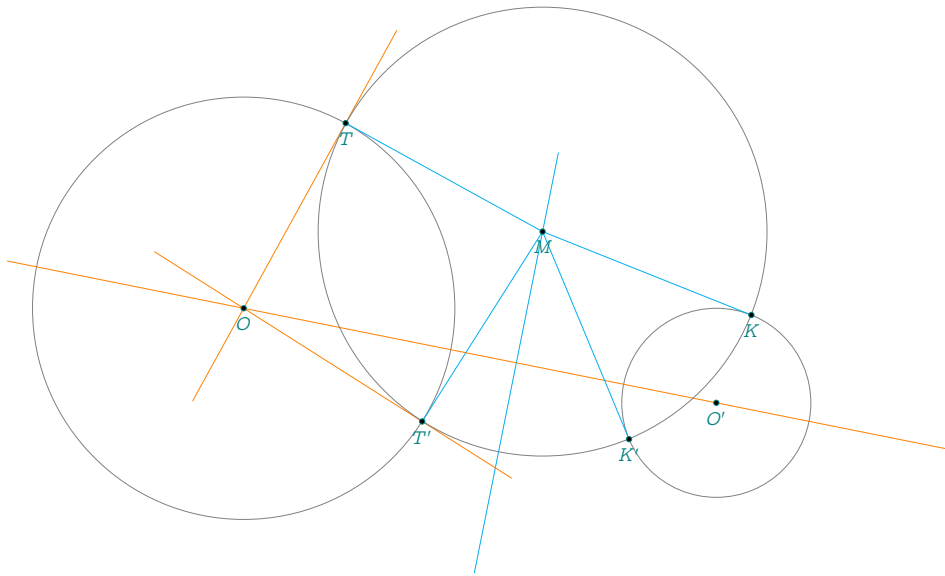

20.38 Midcircles

```

\begin{tkzelements}
z.A      = point: new (0 , 0)
z.B      = point: new (10 , 0)
L.AB     = line : new (z.A,z.B)
z.C      = L.AB: gold_ratio ()
L.AC     = line : new (z.A,z.C)
L.CB     = line : new (z.C,z.B)
z.O_0    = L.AB.mid
z.O_1    = L.AC.mid
z.O_2    = L.CB.mid
C.O0B    = circle : new (z.O_0,z.B)
C.O1C    = circle : new (z.O_1,z.C)
C.O2C    = circle : new (z.O_2,z.B)
z.Q      = C.O1C : midarc (z.C,z.A)
\end{tkzelements}

```

```

z.P      = C.02C : midarc (z.B,z.C)
L.0102   = line : new (z.0_1,z.0_2)
L.0001   = line : new (z.0_0,z.0_1)
L.0002   = line : new (z.0_0,z.0_2)
z.M_0    = L.0102 : harmonic_ext (z.C)
z.M_1    = L.0001 : harmonic_int (z.A)
z.M_2    = L.0002 : harmonic_int (z.B)
L.BQ     = line : new (z.B,z.Q)
L.AP     = line : new (z.A,z.P)
z.S      = intersection (L.BQ,L.AP)
L.CS     = line : new (z.C,z.S)
C.M1A    = circle : new (z.M_1,z.A)
C.M2B    = circle : new (z.M_2,z.B)
z.P_0    = intersection (L.CS,C.00B)
z.P_1    = intersection (C.M2B,C.01C)
z.P_2    = intersection (C.M1A,C.02C)
T.P012   = triangle : new (z.P_0,z.P_1,z.P_2)
z.0_4    = T.P012.circumcenter
T.CP12   = triangle : new (z.C,z.P_1,z.P_2)
z.0_5    = T.CP12.circumcenter
z.BN     = z.B : north ()
L.BBN    = line : new (z.B,z.BN)
L.M1P2   = line : new (z.M_1,z.P_2)
z.J      = intersection (L.BBN,L.M1P2)
L.AP0    = line : new (z.A,z.P_0)
L.BP0    = line : new (z.B,z.P_0)
C.04P0   = circle : new (z.0_4,z.P_0)
_,z.G    = intersection (L.AP0,C.04P0)
z.H      = intersection (L.BP0,C.04P0)
z.Ap     = z.M_1: symmetry (z.A)
z.H_4,z.F,z.E,z.H_0 = L.AB : projection (z.0_4,z.G,z.H,z.P_0)
\end{tkzelements}

\begin{tikzpicture}
\tkzGetNodes
\tkzDrawCircle[thin,fill=green!10](0_4,P_0)
\tkzDrawCircle[purple,fill=purple!10,opacity=.5](0_5,C)
\tkzDrawSemiCircles[teal](0_0,B)
\tkzDrawSemiCircles[thin,teal,fill=teal!20,opacity=.5](0_1,C 0_2,B)
\tkzDrawSemiCircles[color = orange](M_2,B)
\tkzDrawSemiCircles[color = orange](M_1,A')
\tkzDrawArc[purple,delta=0](M_0,P_0)(C)
\tkzDrawSegments[very thin](A,B A,P B,Q)
\tkzDrawSegments[color=cyan](0_0,P_0 B,J G,J G,0_0 H,0_2)
\tkzDrawSegments[ultra thin,purple](M_1,P_0 M_2,P_0 M_1,M_0 M_0,P_1 M_0,P_0 M_1,J)
\tkzDrawPoints(A,B,C,P_0,P_2,P_1,M_0,M_1,M_2,J,P,Q,S)
\tkzDrawPoints(0_0,0_1,0_2,0_4,0_5,G,H)
\tkzMarkRightAngle[size=.2,fill=gray!20,opacity=.4](0_0,P_0,M_0)
\tkzLabelPoints[below](A,B,C,M_0,M_1,M_2,0_1,0_2,0_0)
\tkzLabelPoints[above](P_0,0_5,0_4)
\tkzLabelPoints[above](P_1,J)
\tkzLabelPoints[above](P_2,P,Q,S)
\tkzLabelPoints[above right](H,E)
\tkzLabelPoints[above left](F,G)
\tkzLabelPoints[below right](H_0)
\tkzLabelCircle[below=4pt,font=\scriptsize](0_1,C)(80){\beta}
\tkzLabelCircle[below=4pt,font=\scriptsize](0_2,B)(80){\gamma}

```

```

\tkzLabelCircle[below=4pt,font=\scriptsize](0_0,B)(110){$(\alpha)$}
\tkzLabelCircle[left,font=\scriptsize](0_4,P_2)(60){$(\delta)$}
\tkzLabelCircle[above left,font=\scriptsize](0_5,C)(40){$(\epsilon)$}
\end{tikzpicture}

```

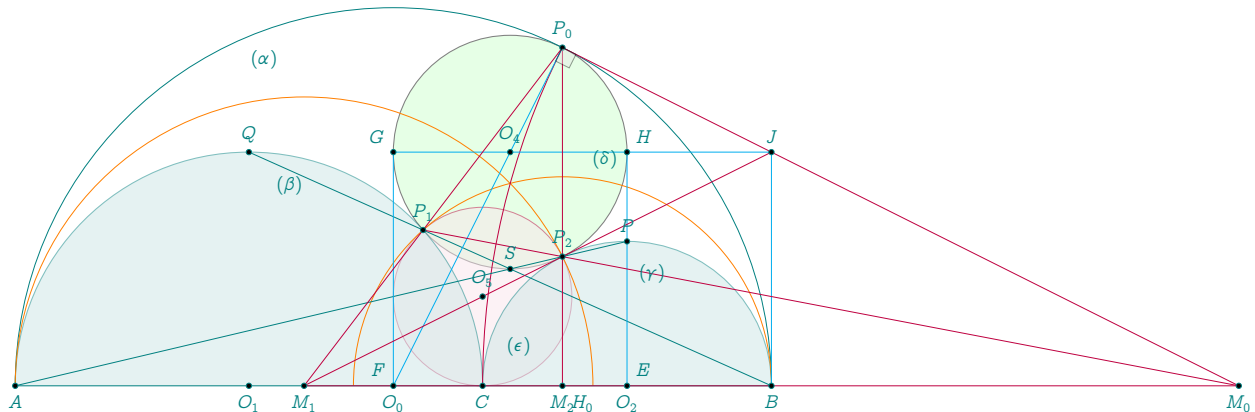

20.39 Pencil v1

```

\begin{tkzelements}
  scale      = .75
  z.A        = point : new (0,2)
  z.B        = point : new (0,-2)
  z.C_0      = point : new (-3,0)
  z.C_1      = point : new (2,0)
  z.C_3      = point : new (2.5,0)
  z.C_5      = point : new (1,0)
  L.BA       = line : new (z.B,z.A)
  z.M_0      = L.BA : point (1.25)
  z.M_1      = L.BA : point (1.5)
  C.C0A      = circle : new (z.C_0,z.A)
  z.x,z.y    = get_points (C.C0A : orthogonal_from (z.M_0))
  z.xp,z.yp  = get_points (C.C0A : orthogonal_from (z.M_1))
  z.O        = L.BA.mid
\end{tkzelements}
\begin{tikzpicture}
  \tkzGetNodes
  \tkzDrawCircles(C_0,A C_1,A C_3,A C_5,A)
  \tkzDrawCircles[thick,color=red](M_0,x M_1,x')
  \tkzDrawCircles[thick,color=blue](O,A)
  \tkzDrawLines(C_0,C_1 B,M_1)
  \tkzDrawPoints(A,B,C_0,C_1,M_0,M_1,x,y)
  \tkzLabelPoints[below right](A,B,C_0,C_1,M_0,M_1,x,y)
  \tkzLabelLine[pos=1.25,right]( M_0,M_1){$(\Delta)$}
\end{tikzpicture}

```

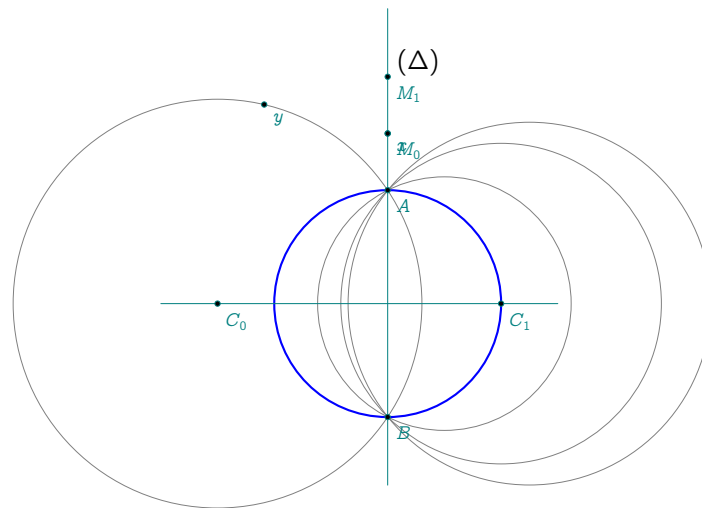

20.40 Pencil v2

```

\begin{tkzelements}
  scale=.75
  z.A = point : new (0,0)
  z.B = point : new (1,0)
  z.C_0 = point : new (-2,0)
  z.C_1 = point : new (4,0)
  C.C0A = circle : new (z.C_0,z.A)
  C.C1B = circle : new (z.C_1,z.B)
  L.EF = C.C0A : radical_axis (C.C1B)
  z.M_0 = L.EF : point (2)
  z.M_1 = L.EF : point (-1)
  z.M_2 = L.EF : point (-2)
  C.orth0 = C.C0A : orthogonal_from (z.M_0)
  C.orth1 = C.C0A : orthogonal_from (z.M_1)
  C.orth2 = C.C0A : orthogonal_from (z.M_2)
  z.u = C.orth0.through
  z.v = C.orth1.through
  z.t = C.orth2.through
\end{tkzelements}
\begin{tikzpicture}
  \tkzGetNodes
  \tkzDrawCircles(C_0,A C_1,B)
  \tkzDrawCircles[thick,color=red](M_0,u M_1,v M_2,t)
  \tkzDrawLines[add= .75 and .75](C_0,C_1 M_0,M_1)
  \tkzDrawPoints(A,B,C_0,C_1,M_0,M_1,M_2)
  \tkzLabelPoints[below right](A,B,C_0,C_1,M_0,M_1,M_2)
  \tkzLabelLine[pos=2,right]( M_0,M_1){$(\Delta)$}
\end{tikzpicture}

```

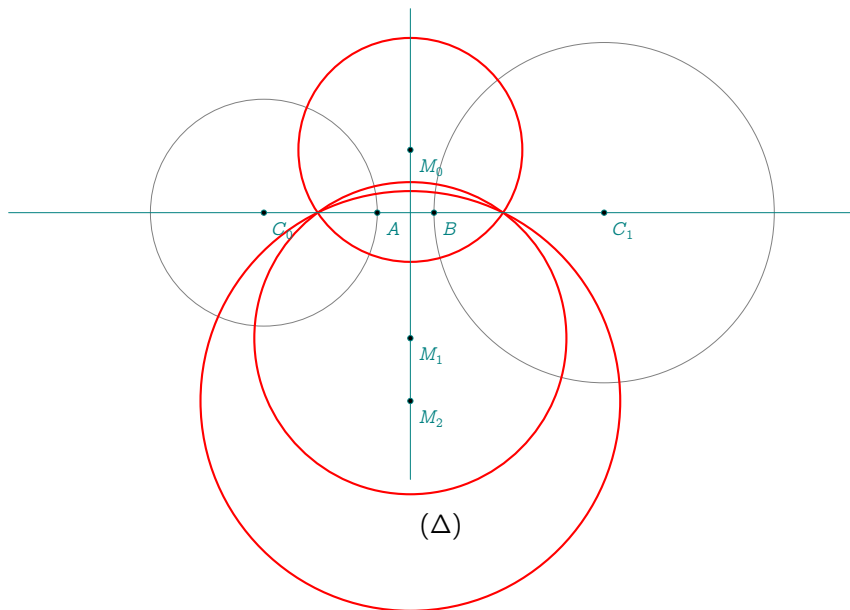

20.41 Power v1

```

\begin{tkzelements}
  z.O      = point : new (0,0)
  z.A      = point : new (2,-2)
  z.M      = point : new (-6,0)
  L.AM     = line : new (z.A,z.M)
  C.OA     = circle : new (z.O,z.A)
  z.Ap     = C.OA : antipode (z.A)
  z.B      = intersection (L.AM, C.OA)
\end{tkzelements}
\begin{tikzpicture}
  \tkzGetNodes
  \tkzDrawCircle(O,A)
  \tkzMarkRightAngle[fill=gray!10](A',B,M)
  \tkzDrawSegments(M,O A,A' A',B)
  \tkzDrawPoints(O,A,A',M,B)
  \tkzLabelPoints(O,A,A',M,B)
  \tkzDrawSegments[-Triangle](M,A M,A')
\end{tikzpicture}

```

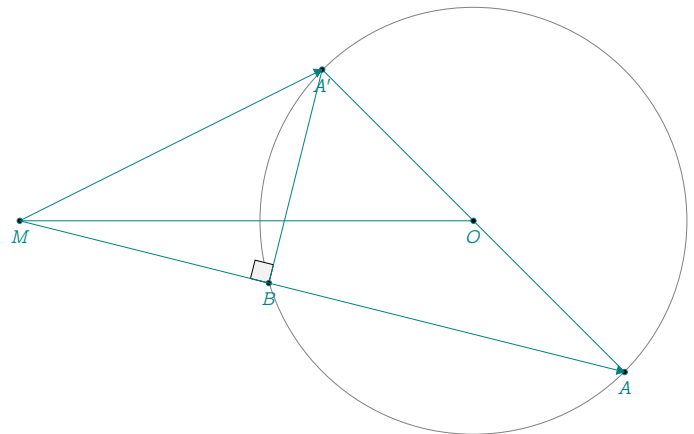

20.42 Power v2

```

\begin{tkzelements}
z.O      = point : new (0,0)
z.A      = point : new (2,2)
z.M      = point : new (-1.5,0)
L.AM     = line : new (z.A,z.M)
C.OA     = circle : new (z.O,z.A)
z.Ap     = C.OA : antipode (z.A)
_,z.B    = intersection (L.AM, C.OA)
z.m      = z.M : north(1)
L.mM     = line : new (z.m,z.M)
z.U,z.V  = intersection (L.mM,C.OA)
\end{tkzelements}
\begin{tikzpicture}
\tkzGetNodes
\tkzDrawCircle(O,A)
\tkzMarkRightAngle[fill=gray!10](A',B,M)
\tkzDrawSegments(M,O A,A' A',B A,B U,V)
\tkzDrawPoints(O,A,A',M,B,U,V,m)
\tkzLabelPoints(O,A,M,U,V,m)
\tkzLabelPoints[below left](A',B)
\tkzDrawSegments(M,A M,A')
\end{tikzpicture}

```

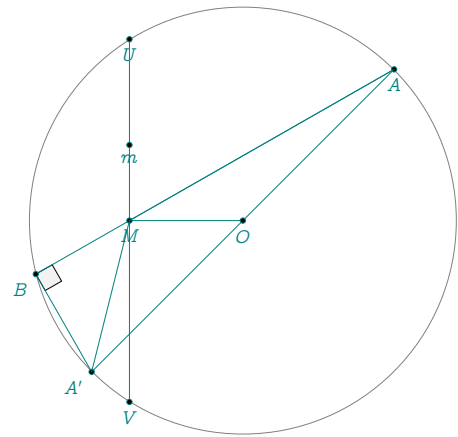

20.43 Reim v1

```

\begin{tkzelements}
z.A      = point: new (0,0)
z.E      = point: new (-2,2)
C.AE     = circle : new (z.A,z.E)
z.C      = C.AE : point (0.65)
z.D      = C.AE : point (0.5)
z.F      = C.AE : point (0.30)
L.EC     = line: new (z.E,z.C)
z.H      = L.EC : point (1.5)
T.CDH    = triangle : new (z.C,z.D,z.H)
z.B      = T.CDH.circumcenter
C.BD     = circle : new (z.B,z.D)
L.FD     = line: new (z.F,z.D)
z.G      = intersection (L.FD,C.BD)
z.O      = intersection (L.EC,L.FD)
\end{tkzelements}
\begin{tikzpicture}
\tkzGetNodes
\tkzDrawCircles(A,E B,H)
\tkzDrawSegments(E,D C,F)
\tkzDrawLines(E,O F,O)
\tkzDrawLines[red](E,F H,G)
\tkzDrawPoints(A,...,H,O)
\tkzLabelPoints(A,B,D,F,G,O)
\tkzLabelPoints[above](E,C,H)
\tkzMarkAngles[size=.5](E,C,F E,D,F)
\tkzFillAngles[green!40,opacity=.4,size=.5](E,C,F E,D,F)
\end{tikzpicture}

```

```

\tkzMarkAngles[size=.5](F,C,H G,D,E)
\tkzFillAngles[red!40,opacity=.4,size=.5](F,C,H G,D,E)
\end{tikzpicture}

```

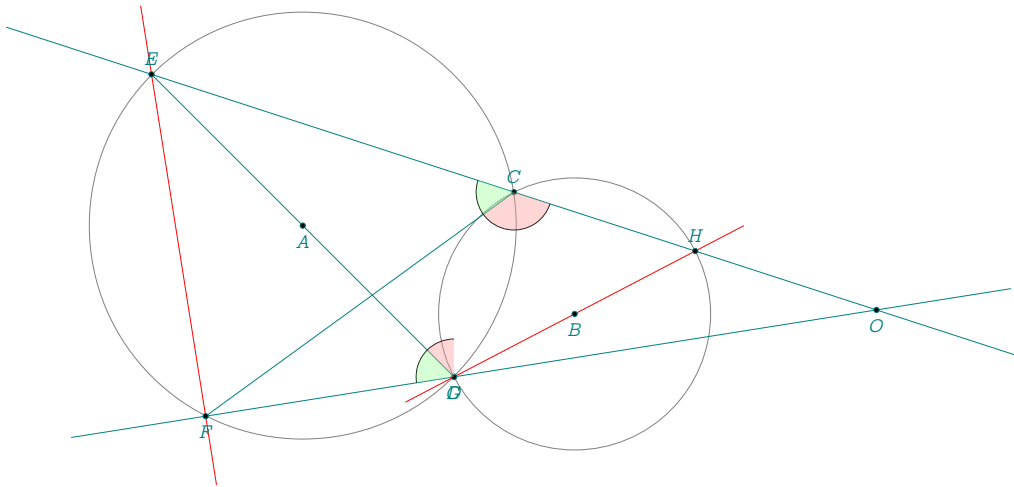

20.44 Reim v2

```

\begin{tkzelements}
  scale = .6
  z.A = point: new (0,0)
  z.B = point: new (10,0)
  z.C = point: new (4,0)
  C.AC = circle: new (z.A,z.C)
  z.c,z.cp = get_points (C.AC: tangent_at (z.C))
  z.M = C.AC: point (0.6)
  L.MC = line: new (z.M,z.C)
  C.BC = circle: new (z.B,z.C)
  z.N = intersection (L.MC,C.BC)
  z.m,z.mp = get_points (C.AC: tangent_at (z.M))
  z.n,z.np = get_points (C.BC: tangent_at (z.N))
\end{tkzelements}
\begin{tikzpicture}
  \tkzGetNodes
  \tkzDrawCircles(A,C B,C)
  \tkzDrawLines[new,add=1 and 1](M,m N,n C,c)
  \tkzDrawSegment(M,N)
  \tkzDrawPoints(A,B,C,M,N)
  \tkzLabelPoints[below right](A,B,C,M,N)
  \tkzFillAngles[blue!30,opacity=.3](m',M,C N,C,c' M,C,c n',N,C)
  \tkzLabelCircle[below=4pt,font=\scriptsize](A,C)(90){$(\alpha)$}
  \tkzLabelCircle[left=4pt,font=\scriptsize](B,C)(-90){$(\beta)$}
\end{tikzpicture}

```

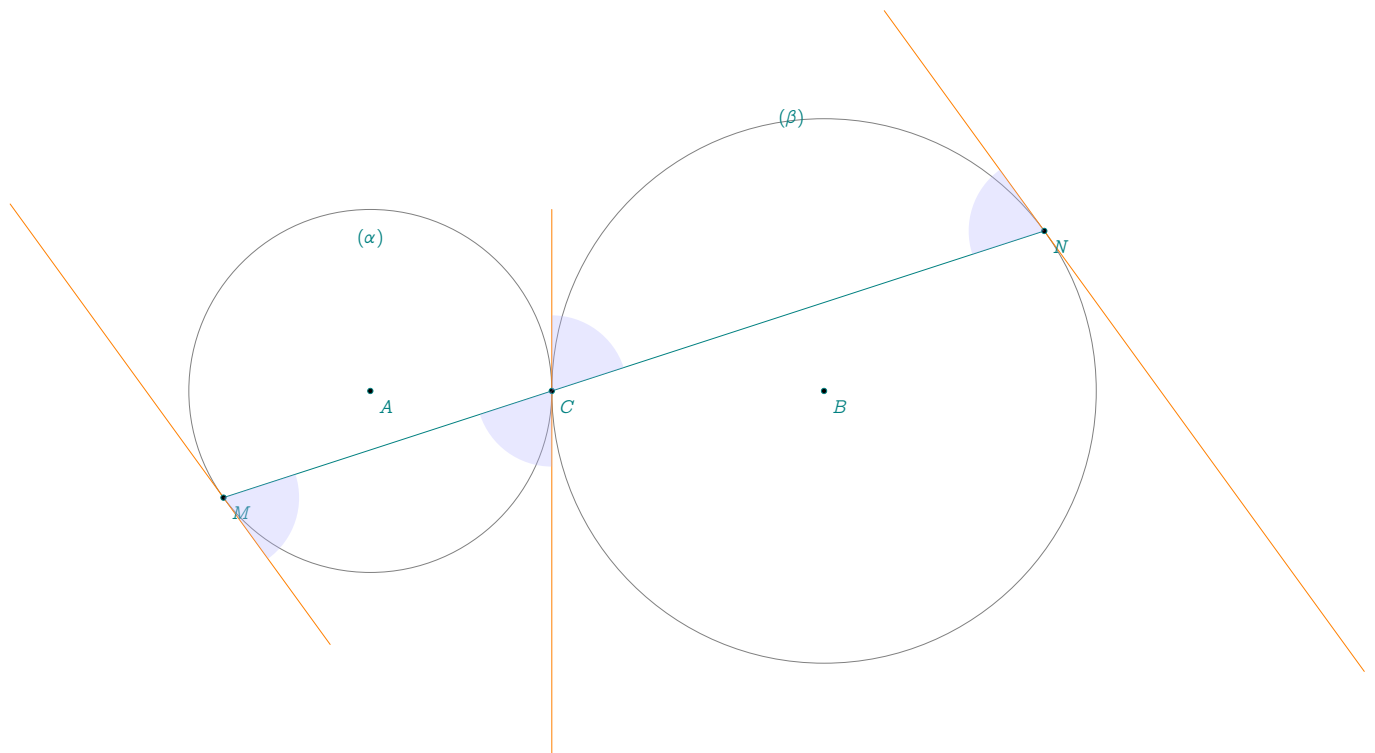

20.45 Reim v3

```

\begin{tkzelements}
  z.A   = point: new (0,0)
  z.B   = point: new (8,0)
  z.C   = point: new (2,6)
  L.AB  = line : new (z.A,z.B)
  L.AC  = line : new (z.A,z.C)
  L.BC  = line : new (z.B,z.C)
  z.I   = L.BC : point (0.75)
  z.J   = L.AC : point (0.4)
  z.K   = L.AB : point (0.5)
  T.AKJ = triangle : new (z.A,z.K,z.J)
  T.BIK = triangle : new (z.B,z.I,z.K)
  T.CIJ = triangle : new (z.C,z.I,z.J)
  z.x   = T.AKJ.circumcenter
  z.y   = T.BIK.circumcenter
  z.z   = T.CIJ.circumcenter
  C.xK  = circle: new (z.x,z.K)
  C.yK  = circle: new (z.y,z.K)
  z.O,_ = intersection (C.xK,C.yK)
  C.z0  = circle: new (z.z,z.O)
  L.K0  = line: new (z.K,z.O)
  z.D   = intersection (L.K0,C.z0)
\end{tkzelements}

\begin{tikzpicture}
  \tkzGetNodes
  \tkzDrawSegments(K,D D,C)

```

20.46 Tangent and circle

```

\begin{tkzelements}
  z.A      = point:   new (1,0)
  z.B      = point:   new (2,2)
  z.E      = point:   new (5,-4)
  L.AE     = line :   new (z.A,z.E)
  C.AB     = circle:  new (z.A , z.B)
  z.S      = C.AB.south
  z.M      = L.AE.mid
  L.Ti,L.Tj = C.AB:   tangent_from (z.E)
  z.i      = L.Ti.pb
  z.j      = L.Tj.pb
  z.k,z.l  = get_points (C.AB: tangent_at (z.B))
\end{tkzelements}
\begin{tikzpicture}
  \tkzGetNodes
  \tkzDrawCircles(A,B M,A)
  \tkzDrawPoints(A,B,E,i,j,M,S)
  \tkzDrawLines(E,i E,j k,l)
  \tkzLabelPoints[right,font=\small](A,B,E,S,M)
\end{tikzpicture}

```

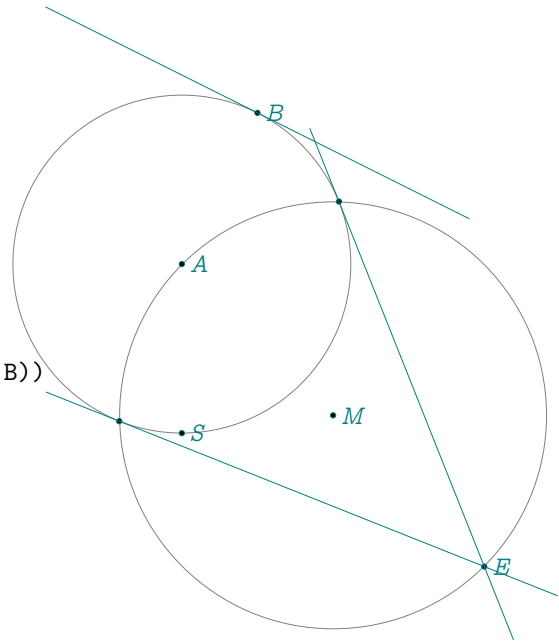

20.47 Homothety

```

\begin{tkzelements}
  z.A      = point:   new (0,0)
  z.B      = point:   new (1,2)
  z.E      = point:   new (-3,2)
  z.C,z.D  = z.E : homothety(2,z.A,z.B)
\end{tkzelements}
\begin{tikzpicture}
  \tkzGetNodes
  \tkzDrawPoints(A,B,C,E,D)
  \tkzLabelPoints(A,B,C,E)
  \tkzDrawCircles(A,B C,D)
  \tkzDrawLines(E,C E,D)
\end{tikzpicture}

```

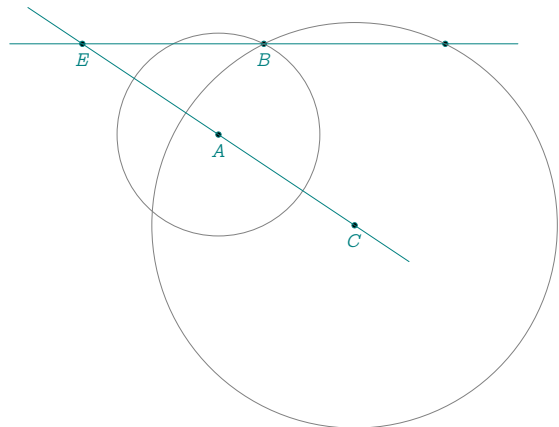

20.48 Tangent and chord

```

\begin{tkzelements}
  scale      = .8
  z.A        = point: new (0 , 0)
  z.B        = point: new (6 , 0)
  z.C        = point: new (1 , 5)
  z.Bp       = point: new (2 , 0)
  T.ABC      = triangle: new (z.A,z.B,z.C)
  L.AB       = line: new (z.A,z.B)
  z.O        = T.ABC.circumcenter
  C.OA       = circle: new (z.O,z.A)
  z.D        = C.OA: point (4.5)
  L.AO       = line: new (z.A,z.O)
  z.b1,z.b2  = get_points (C.OA: tangent_at (z.B))
  z.H        = L.AB: projection (z.O)
\end{tkzelements}
\begin{tikzpicture}
  \tkzGetNodes
  \tkzDrawCircle(O,A)
  \tkzDrawPolygon(A,B,C)
  \tkzDrawSegments[new] (A,O B,O O,H A,D D,B)
  \tkzDrawLine(b1,b2)
  \tkzDrawPoints(A,B,C,D,H,O)
  \tkzFillAngles[green!20,opacity=.3] (H,O,B A,C,B A,B,b1)
  \tkzFillAngles[teal!20,opacity=.3] (A,D,B b2,B,A)
  \tkzLabelPoints(A,B,C,D,H,O)
\end{tikzpicture}

```

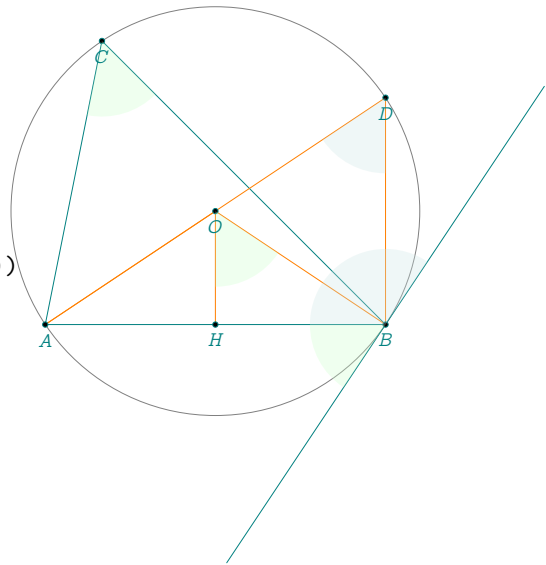

20.49 Three chords

```

\begin{tkzelements}
z.O = point: new (0 , 0)
z.B = point: new (0 , 2)
z.P = point: new (1 , -.5)
C.OB = circle : new (z.O,z.B)
C.PB = circle : new (z.P,z.B)
_,z.A = intersection (C.OB,C.PB)
z.D = C.PB: point(0.85)
z.C = C.PB: point(0.5)
z.E = C.OB: point(0.6)
L.AB = line : new (z.A,z.B)
L.CD = line : new (z.C,z.D)
z.G = intersection (L.AB,L.CD)
L.GE = line : new (z.G,z.E)
z.F,_ = intersection (L.GE,C.OB)
T.CDE = triangle: new (z.C,z.D,z.E)
T.BFD = triangle: new (z.B,z.F,z.D)
z.w = T.CDE.circumcenter
z.x = T.BFD.circumcenter
L.GB = line : new (z.G,z.B)
L.GE = line : new (z.G,z.E)
L.GD = line : new (z.G,z.D)
C.xB = circle : new (z.x,z.B)

```

```

C.xF = circle : new (z.x,z.F)
C.xD = circle : new (z.x,z.D)
z.Ap = intersection (L.GB,C.xB)
z.Ep,_ = intersection (L.GE,C.xF)
z.Cp,_ = intersection (L.GD,C.xD)
\end{tkzelements}
\begin{tikzpicture}
  \tkzGetNodes
  \tkzDrawCircles(O,B)
  \tkzDrawCircles[cyan](P,B)
  \tkzDrawCircles[red](w,E)
  \tkzDrawCircles[new](x,F)
  \tkzDrawSegments(A,G E,G C,G)
  \tkzDrawPolygons[new](A,E,C A',E',C')
  \tkzDrawPoints(A,...,G,A',E',C',O,P)
  \begin{scope}[font=\scriptsize]
    \tkzLabelPoints(A,...,F)
    \tkzLabelPoints[above left](G,A',E',C')
    \tkzLabelCircle[left](O,B)(30){$(\beta)$}
    \tkzLabelCircle[below](P,A)(40){$(\gamma)$}
    \tkzLabelCircle[right](w,C)(90){$(\alpha)$}
    \tkzLabelCircle[left](x,B)(-230){$(\delta)$}
  \end{scope}
\end{tikzpicture}

```

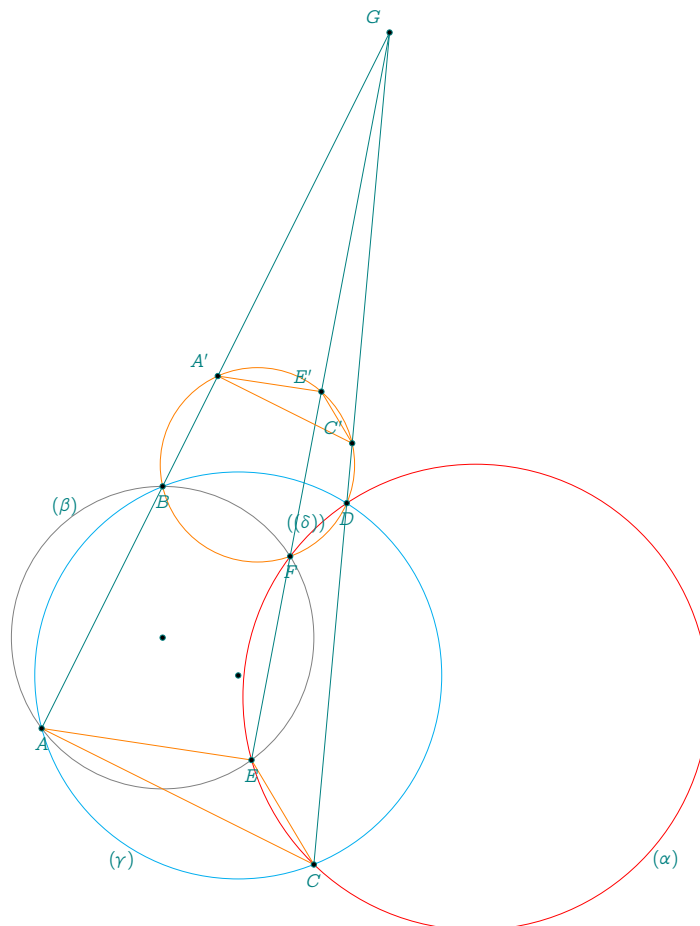

20.50 Three tangents

```

\begin{tkzelements}
z.A = point: new (-1 , 0)
z.C = point: new (4 , -1.5)
z.E = point: new (1 , -1)
z.F = point: new (1.5 , 2.5)
T.AEF = triangle : new (z.A,z.E,z.F)
T.CEF = triangle : new (z.C,z.E,z.F)
z.w = T.AEF.circumcenter
z.x = T.CEF.circumcenter
C.wE = circle : new (z.w,z.E)
C.xE = circle : new (z.x,z.E)
L.Aw = line : new (z.A,z.w)
L.Cx = line : new (z.C,z.x)
z.G = intersection (L.Aw,L.Cx)
L.TA = C.wE : tangent_at (z.A)
L.TC = C.xE : tangent_at (z.C)
z.I = intersection (L.TA,L.TC)
\end{tkzelements}
\begin{tikzpicture}
\tkzGetNodes
\tkzDrawCircles(w,E)
\tkzDrawCircles[cyan](x,E)
\tkzDrawCircles[red](G,A)
\tkzDrawLines(A,I C,I F,I)
\tkzDrawPoints(A,C,E,F)
\tkzLabelPoints[right](A)
\tkzLabelPoints[above right](E,F)
\tkzLabelPoints[below](C)
\end{tikzpicture}

```

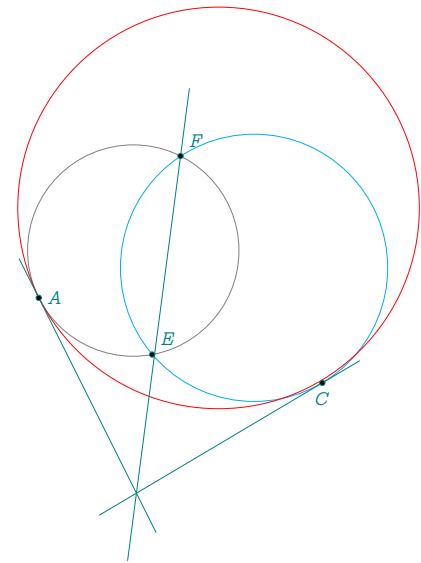

20.51 Midarc

```

\begin{tkzelements}
z.A = point: new (-1,0)
z.B = point: new (2,4)
C.AB = circle: new (z.A,z.B)
z.C = z.A: rotation (math.pi/3,z.B)
z.D = C.AB: midarc (z.B,z.C)
\end{tkzelements}
\begin{tikzpicture}
\tkzGetNodes
\tkzDrawPoints(A,B,C)
\tkzDrawCircles(A,B)
\tkzDrawPoints(A,...,D)
\tkzLabelPoints(A,...,D)
\end{tikzpicture}

```

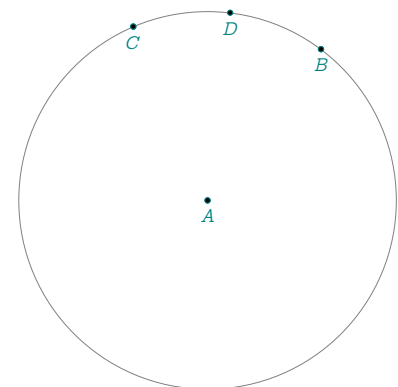

20.52 Lemoine Line without macro

```

\begin{tkzelements}
  scale      = 1.6
  z.A        = point: new (1,0)
  z.B        = point: new (5,2)
  z.C        = point: new (1.2,2)
  T          = triangle: new(z.A,z.B,z.C)
  z.O        = T.circumcenter
  L.AB       = line: new (z.A,z.B)
  L.AC       = line: new (z.A,z.C)
  L.BC       = line: new (z.B,z.C)
  C.OA       = circle: new (z.O,z.A)
  z.Ar,z.A1  = get_points (C.OA: tangent_at (z.A))
  z.Br,z.B1  = get_points (C.OA: tangent_at (z.B))
  z.Cr,z.C1  = get_points (C.OA: tangent_at (z.C))
  L.tA       = line: new (z.Ar,z.A1)
  L.tB       = line: new (z.Br,z.B1)
  L.tC       = line: new (z.Cr,z.C1)
  z.P        = intersection (L.tA,L.BC)
  z.Q        = intersection (L.tB,L.AC)
  z.R        = intersection (L.tC,L.AB)
\end{tkzelements}

```

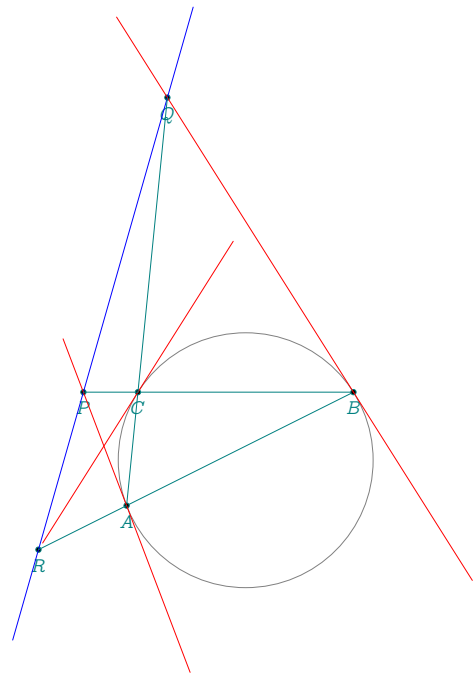

```

\end{tikzpicture}
\begin{tikzpicture}
  \tkzGetNodes
  \tkzDrawPolygon[teal](A,B,C)
  \tkzDrawCircle(O,A)
  \tkzDrawPoints(A,B,C,P,Q,R)
  \tkzLabelPoints(A,B,C,P,Q,R)
  \tkzDrawLine[blue](Q,R)
  \tkzDrawLines[red](Ar,A1 Br,Q Cr,C1)
  \tkzDrawSegments(A,R C,P C,Q)
\end{tikzpicture}

```

20.53 First Lemoine circle

```

\begin{tkzelements}
  z.A        = point: new (1,1)
  z.B        = point: new (5,1)
  z.C        = point: new (2,3)
  T          = triangle: new (z.A,z.B,z.C)
  z.O        = T.circumcenter
  z.o,z.w    = get_points (T : first_lemoine_circle ())
  z.L        = T : lemoine_point ()
\end{tkzelements}

```

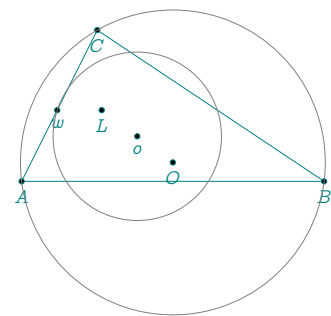

```

\begin{tikzpicture}
  \tkzGetNodes
  \tkzDrawPolygons(A,B,C)
  \tkzDrawPoints(A,B,C,o,w,O,L)
  \tkzLabelPoints(A,B,C,o,w,O,L)
  \tkzDrawCircles(o,w O,A)
\end{tikzpicture}

```

20.54 First and second Lemoine circles

```

\begin{tkzelements}
  scale          = 2
  z.a            = point: new (0,0)
  z.b            = point: new (5,0)
  z.c            = point: new (2,3)
  T              = triangle: new (z.a,z.b,z.c)
  z.O            = T.circumcenter
  z.o,z.p        = get_points (T : first_lemoine_circle ())
  L.ab           = line : new (z.a,z.b)
  L.ca           = line : new (z.c,z.a)
  L.bc           = line : new (z.b,z.c)
  z.L,z.x        = get_points (T : second_lemoine_circle ())
  C.first_lemoine = circle : new (z.o,z.p)
  z.y1,z.y2      = intersection (L.ab,C.first_lemoine)
  z.y5,z.y6      = intersection (L.bc,C.first_lemoine)
  z.y3,z.y4      = intersection (L.ca,C.first_lemoine)
  C.second_lemoine = circle : new (z.L,z.x)
  z.x1,z.x2      = intersection (L.ab,C.second_lemoine)
  z.x3,z.x4      = intersection (L.bc,C.second_lemoine)
  z.x5,z.x6      = intersection (L.ca,C.second_lemoine)
  L.y1y6         = line : new (z.y1,z.y6)
  L.y4y5         = line : new (z.y4,z.y5)
  L.y2y3         = line : new (z.y2,z.y3)
\end{tkzelements}
\begin{tikzpicture}
  \tkzGetNodes
  \tkzDrawPolygons(a,b,c y1,y2,y3,y4,y5,y6)
  \tkzDrawPoints(x1,x2,x3,x4,x5,x6,L)
  \tkzDrawPoints(a,b,c,o,0,y1,y2,y3,y4,y5,y6)
  \tkzLabelPoints[below right](a,b,c,o,0,y1,y2,y3,y4,y5,y6)
  \tkzLabelPoints[below left](x1,x2,x3,x4,x5,x6)
  \tkzLabelPoints[above](L)
  \tkzDrawCircles(L,x o,p 0,a)
  \tkzDrawSegments(L,0 x1,x4 x2,x5 x3,x6)
\end{tikzpicture}

```

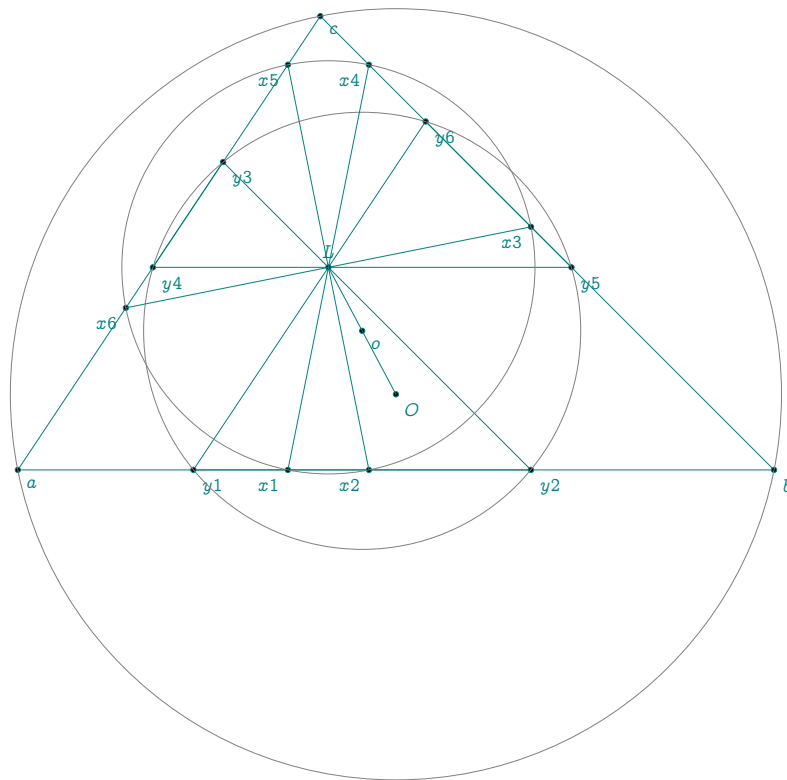

20.55 Inversion

```

\begin{tkzelements}
  z.A      = point: new (-1,0)
  z.B      = point: new (2,2)
  z.C      = point: new (2,4)
  z.E      = point: new (1,6)
  C.AC     = circle:  new (z.A,z.C)
  L.Tt1,L.Tt2 = C.AC: tangent_from (z.E)
  z.t1     = L.Tt1.pb
  z.t2     = L.Tt2.pb
  L.AE     = line: new (z.A,z.E)
  z.H      = L.AE : projection (z.t1)
  z.Bp,
  z.Ep,
  z.Cp     = C.AC: inversion ( z.B, z.E, z.C )
\end{tkzelements}

\begin{tikzpicture}
  \tkzGetNodes
  \tkzDrawPoints(A,B,C)
  \tkzDrawCircles(A,C A,B)
  \tkzDrawLines(A,B' E,t1 E,t2 t1,t2 A,E)
  \tkzDrawPoints(A,B,C,E,t1,t2,H,B',E')
  \tkzLabelPoints(A,B,C,E,t1,t2,B',E')
  \tkzLabelPoints[above](C')
\end{tikzpicture}

```

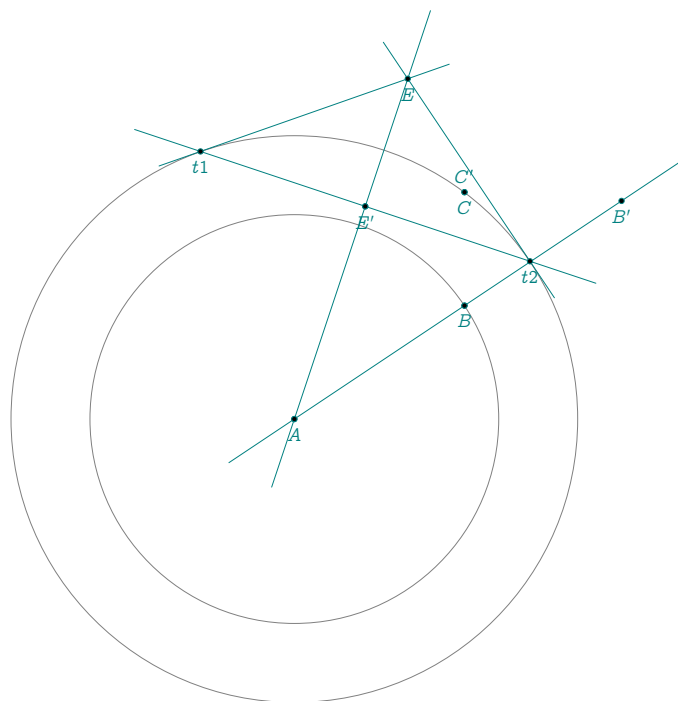

20.56 Gergonne point

```

\begin{tkzelements}
  z.a = point: new(1,0)
  z.b = point: new(6,2)
  z.c = point: new(2,5)
  T = triangle : new (z.a,z.b,z.c)
  z.g = T : gergonne_point ()
  z.i = T.incenter
  z.ta,z.tb,z.tc = get_points (T : intouch ())
end{tkzelements}
\begin{tikzpicture}
  \tkzGetNodes
  \tkzDrawPolygons(a,b,c)
  \tkzDrawPoints(a,b,c,g)
  \tkzLabelPoints(a,b,c)
  \tkzDrawSegments (a,ta b,tb c,tc)
  \tkzDrawCircle(i,ta)
\end{tikzpicture}

```

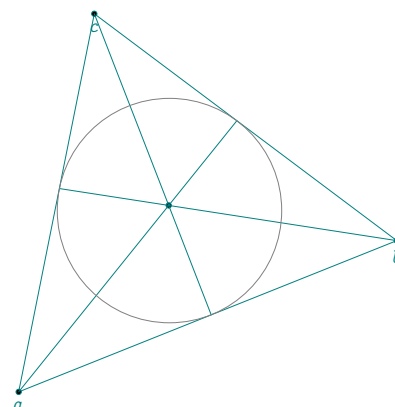

20.57 Antiparallel through Lemoine point

```

\begin{tkzelements}
  z.a      = point: new (0,0)
  z.b      = point: new (5,0)
  z.c      = point: new (1,4)
  T        = triangle: new (z.a,z.b,z.c)
  z.L      = T : lemoine_point ()
  L.anti   = T : antiparallel (z.L,0)
  z.x_0,z.x_1 = get_points (L.anti)
  L.anti   = T : antiparallel (z.L,1)
  z.y_0,z.y_1 = get_points (L.anti)
  L.anti   = T : antiparallel (z.L,2)
  z.z_0,z.z_1 = get_points (L.anti)
\end{tkzelements}

\begin{tikzpicture}
  \tkzGetNodes
  \tkzDrawPolygons(a,b,c)
  \tkzDrawPoints(a,b,c,L,x_0,x_1,y_0,y_1,z_0,z_1)
  \tkzLabelPoints(a,b)
  \tkzLabelPoints[above](L,c)
  \tkzDrawSegments(x_0,x_1 y_0,y_1 z_0,z_1)
  \tkzDrawCircle(L,x_0)
\end{tikzpicture}

```

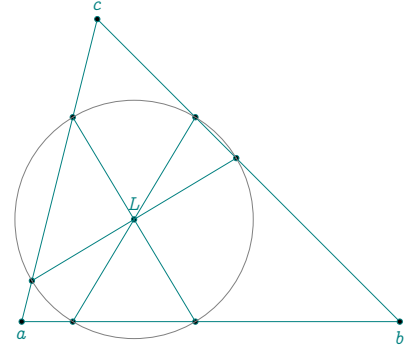

Index

- attribute, 13
- circle: attribute
 - center, 29
 - east, 29
 - north, 29
 - radius, 29
 - south, 29
 - through, 29
 - type, 29
 - west, 29
- circle: method
 - antipode (pt), 30
 - draw (), 30
 - external_similitude (C), 30
 - in_out (pt), 30
 - in_out_disk (pt), 30
 - internal_similitude (C), 30
 - inversion (circle), 30
 - inversion (line), 30
 - inversion (pt), 30
 - midarc (z1,z2), 30
 - new(O,A), 30
 - orthogonal_from (pt), 30
 - orthogonal_through (pta,ptb), 30
 - point (t), 30
 - power (pt), 30
 - radical_axis (C), 30
 - radius(O,r), 30
 - random_pt(lower, upper), 30
 - tangent_at (pt), 30
 - tangent_from (pt), 30
- Class
 - circle, 4, 29
 - class, 16
 - ellipse, 4, 40
 - line, 4, 23
 - parallelogram, 4, 51
 - point, 4, 17
 - Quadrilateral, 44
 - quadrilateral, 4
 - rectangle, 4, 48
 - Regular Polygon, 53
 - regular_polygon, 4
 - square, 4, 46
 - triangle, 4, 34
- ellipse: attribute
 - Fa, 40
 - Fb, 40
 - Rx, 40
 - Ry, 40
 - center, 40, 41
 - covertex, 40, 41
 - slope, 40
 - type, 40
 - vertex, 40, 41
- ellipse: method
 - east, 40
 - foci (f1,f2,v), 41
 - foci, 42
 - in_out (pt) , 41
 - new (pc, pa ,pb) , 41
 - new, 41
 - north, 40
 - point (t) , 41
 - point, 43
 - radii (c,a,b,sl) , 41
 - radii, 43
 - south, 40
 - tangent_at (pt) , 41
 - tangent_from (pt) , 41
 - west, 40
- Environment
 - luacode, 4, 8
 - tikzpicture, 8, 12, 41
 - tkzelements, 4, 8, 12, 14, 41, 43
- line: attribute
 - east, 23
 - length, 23
 - mid, 23
 - north_pa, 23
 - north_pb, 23
 - pa, 23
 - pb, 23
 - slope, 23
 - south_pa, 23
 - south_pb, 23
 - type, 23
 - west, 23
- line: method
 - barycenter (ka,kb), 25
 - circle (), 25
 - circle_swap (), 25
 - distance (pt), 25
 - equilateral (swap), 25
 - euclide (swap), 25
 - gold (swap), 25
 - gold_ratio (), 25
 - golden (swap), 25
 - harmonic_both (k), 25
 - harmonic_ext (pt), 25
 - harmonic_int , 25
 - in_out (pt), 25
 - in_out, 68
 - isosceles (phi,swap), 25
 - ll_from (pt), 25
 - mediator (), 25
 - midpoint (), 25
 - new(A, B), 25
 - new, 24

- normalize (), 25
- normalize_inv (), 25
- ortho_from (pt), 25
- point (t), 25
- projection (obj), 25
- reflection (obj), 25
- slope (), 25
- square (), 25
- translation (obj), 25
- math: function
 - angle_normalize (a) , 54
 - barycenter ({z1,n1},{z2,n2}, ...), 54
 - islinear (z1,z2,z3) , 54
 - isortho (z1,z2,z3), 54
 - radical_center (C1,C2,C3), 54
 - radical_circle (C1,C2,C3), 54
 - real (v) , 54
 - tkzinvphi, 54
 - tkzphi, 54
 - tkzsqrtphi, 54
 - value (v) , 54
- math: method
 - aligned, 69
 - islinear, 68, 69
 - isortho, 69
- obj: method
 - new, 16
- Object
 - circle, 16
 - ellipse, 16
 - line, 16, 25
 - parallelogram, 16
 - point, 16, 20
 - quadrilateral, 16
 - rectangle, 16
 - regular_polygon, 16
 - square, 16
 - triangle, 16
- Package
 - ifthen, 12, 67
 - luacode, 4
 - tkz-elements.sty, 4
- package: function
 - \tkzUseLua, 55
 - set_lua_to_tex (list), 42, 54
 - set_lua_to_tex, 41
 - tkzUseLua (variable), 54
- parallelogram: attribute
 - ab, 51
 - ac, 51
 - ad, 51
 - bc, 51
 - bd, 51
 - cd, 51
 - i, 51
 - pa, 51
 - pb, 51
 - pc, 51
 - pd, 51
 - type, 51
- parallelogram: method
 - fourth (za,zb,zc), 52
- point: attribute
 - argument, 17
 - im, 17
 - module, 17
 - re, 17
 - type, 17
- point: method
 - abs (z), 64
 - arg (z), 64
 - conj(z), 64
 - get(z), 64
 - mod(z), 64
 - norm (z), 64
 - north (d), 20
 - polar, 21
 - sqrt(z), 64
- prime, 12
- quadrilateral: attribute
 - ab, 44
 - ac, 44
 - ad, 44
 - a, 44
 - bc, 44
 - bd, 44
 - b, 44
 - cd, 44
 - c, 44
 - d, 44
 - g, 44
 - i, 44
 - pa, 44
 - pb, 44
 - pc, 44
 - pd, 44
 - type, 44
- quadrilateral: method
 - iscyclic (), 44
- real, 55
- rectangle: attribute
 - ab, 48
 - ac, 48
 - ad, 48
 - bc, 48
 - bd, 48
 - cd, 48
 - center, 48
 - diagonal, 48
 - length, 48
 - pa, 48

- pb, 48
- pc, 48
- pd, 48
- type, 48
- width, 48
- rectangle: method
 - angle (zi,za,angle), 49
 - diagonal (za,zc), 49
 - get_lengths (), 49
 - gold (za,zb), 49
 - side (za,zb,d), 49
- regular_polygon: method
 - incircle (), 53
 - name (string), 53
 - new(O,A,n), 53
- square: attribute
 - ab, 46
 - ac, 46
 - ad, 46
 - angle, 53
 - bc, 46
 - bd, 46
 - cd, 46
 - center, 46, 53
 - circle, 53
 - extradius, 46, 53
 - inradius, 46, 53
 - pa, 46
 - pb, 46
 - pc, 46
 - pd, 46
 - proj, 46, 53
 - side, 46, 53
 - table, 53
 - through, 53
 - type, 46, 53
- square: method
 - rotation (zi,za), 47
 - side (za,zb), 47
- \tkzDrawEllipse, 41
- \tkzGetNodes, 7, 8, 12, 14, 63
- \tkzUseLua(value), 15
- triangle: attribute
 - ab, 34
 - ac, 34
 - alpha, 34
 - a, 34
 - bc, 34
 - beta, 34
 - b, 34
 - centroid, 34
 - circumcenter, 34
 - c, 34
 - eulercenter, 34
 - gamma, 34
 - incenter, 34
 - orthocenter, 34
 - pa, 34
 - pb, 34
 - pc, 34
 - spiekercenter, 34
 - type, 34
- triangle: method
 - altitude (n) , 36
 - anti () , 37
 - antiparallel(pt,n), 36
 - area (), 37
 - barycenter (ka,kb,kc), 36
 - barycentric_coordinates (pt), 37
 - base (u,v) , 36
 - bevan_point (), 36
 - bisector (n) , 36
 - bisector_ext(n) , 36
 - cevian (pt), 37
 - check_equilateral (), 37
 - circum_circle (), 37
 - euler (), 37
 - euler_circle (), 37
 - euler_line () , 36
 - euler_points () , 36
 - ex_circle (n), 37
 - excentral () , 37
 - extouch (), 37
 - feuerbach (), 37
 - feuerbach_point () , 36
 - first_lemoine_circle (), 37
 - gergonne_point (), 36
 - in_circle (), 37
 - in_out (pt), 37
 - incentral (), 37
 - intouch () , 37
 - lemoine_point (), 36
 - medial (), 37
 - mittenpunkt_point (), 36
 - nagel_point () , 36
 - new, 34, 36
 - nine_points () , 36
 - orthic (), 37
 - parallelogram (), 36
 - projection (p) , 36
 - second_lemoine_circle (), 37
 - spieker_center (), 36
 - spieker_circle (), 37
 - symmedian (), 37
 - symmedian_line (n), 36
 - symmedian_point () , 36
 - tangential (), 37
- underscore, 13
- value, 55